



Investor Presentation – August 2023

NASDAQ:PPTA

TSX: PPTA

Perpetua Resources

Responsible Mining.

Critical Resources.

Clean Future.



FORWARD-LOOKING STATEMENTS

Information and statements contained in this presentation that are not historical facts are “forward-looking information” or “forward-looking statements” (collectively, “Forward-Looking Information”) within the meaning of applicable Canadian securities legislation and the United States Private Securities Litigation Reform Act of 1995. We use words such as “may,” “would,” “could,” “should,” “will,” “likely,” “expect,” “anticipate,” “believe,” “intend,” “plan,” “forecast,” “outlook,” “project,” “estimate” and similar expressions suggesting future outcomes or events to identify forward-looking statements or forward-looking information. Forward-Looking Information includes, but is not limited to, information concerning the business of Perpetua Resources Corp. (the “Company”), the Stibnite Gold Project (the “Project”), including but not limited to statements with respect to results of the FS (as defined below); disclosure regarding possible events, conditions or financial performance that is based on assumptions about future economic conditions and courses of action; next steps and courses of action including environmental clean up actions by us and our contractors; our ability to comply with and obtain permits related to the Stibnite Gold Project; actions to be taken by the USFS, the Department of Defense, the State of Idaho and other government agencies and regulatory bodies; negotiation of the definitized agreement and anticipated approval of reimbursement requests; our ability to successfully implement and fund the Project and the occurrence of the expected benefits from the Project; timing of the Final Environmental Impact Statement (“FEIS”), Draft Record of Decision, Final Record of Decision and other anticipated milestones related to the Project; expected funding from the Department of Defense; predictions regarding improvements to water quality, water temperature, and fish habitats and other environmental conditions at the site, including with respect to process and timing of such improvements; reduction of the Project footprint and the anticipated benefits and other effects thereof; our ability to successfully implement the Project and the occurrence of the expected benefits from the Project, including contributions to the workforce, national security and clean energy transition; our and Ambri, Inc.’s (“Ambri”) ability to perform under the supply agreement described in this presentation, which agreement is subject to certain conditions, including completion of the permitting process for the Project, commencement of commercial production of antimony, identification of one or more refiners to transform our antimony concentrate into antimony metal, and mutual agreement on certain material terms, including volume and pricing; the anticipated economic, environmental and other benefits of the Project; the viability of the Project; development and operating costs in the event that a production decision is made; success of exploration, development and environmental protection, closure and remediation activities; permitting time lines and requirements; requirements for additional capital; requirements for additional water rights and the potential effect of proposed notices of environmental conditions relating to mineral claims; risks and opportunities associated with the Project; planned exploration and development of properties and the results thereof; planned expenditures, production schedules and budgets and the execution thereof. Statements concerning mineral resource and mineral reserve estimates may also constitute Forward-Looking Information to the extent that they involve estimates of the mineralization that may be encountered if the Project is developed. In preparing the Forward-Looking Information herein, the Company has applied several material assumptions, including, but not limited to, assumptions that we will successfully negotiate a definitized agreement and that the full amount of the Defense Production Act award will be funded on the expected timeline; that the review process under the NEPA (including any joint review process involving the USFS, the State of Idaho and other agencies and regulatory bodies) as well as the FEIS will proceed in a timely manner and as expected; that we will be able to obtain sufficient funding to finance permitting, pre-construction and construction of the Project and that all requisite information will be available in a timely manner; the exchange rates for the U.S. and Canadian currencies will be consistent with the Company’s expectations; that the current exploration, development, environmental and other objectives concerning the Project can be achieved and that its other corporate activities will proceed as expected; that the current price and demand for gold and antimony will be sustained or will improve; that general business and economic conditions will not change in a materially adverse manner and that all necessary governmental approvals for planned activities on the Project will be obtained in a timely manner and on acceptable terms; that permitting and operations costs will not materially increase; the continuity of the price of gold and other metals, economic and political conditions and operations; and the assumptions set out in the FS. Forward-Looking Information involves known and unknown risks, uncertainties and other factors which may cause the actual results, performance or achievements of the Company to be materially different from any future results, performance or achievements expressed or implied by the Forward-Looking Information. Such risks and other factors include, among others, the industry-wide risks and project-specific risks identified in the FS; operations and contractual obligations; changes in exploration programs based upon results of exploration; changes in estimated mineral reserves or mineral resources; future prices of metals and minerals; availability of personnel and equipment; equipment failure; accidents, effects of weather and other natural phenomena and other risks associated with the mineral exploration industry; environmental risks, including environmental matters under US federal and Idaho rules and regulations; impact of environmental remediation requirements and the terms of existing and potential consent decrees on the Company’s planned exploration and development activities on the Project; certainty of mineral title; community relations; delays in obtaining governmental approvals or financing; the Company’s dependence on one mineral project; the nature of mineral exploration and mining and the uncertain commercial viability; the Company’s lack of operating revenues; governmental regulations and the ability to obtain necessary licenses and permits; risks related to prior unregistered agreements, transfers or claims and other defects in title to mineral projects; currency fluctuations; changes in environmental laws and regulations and changes in the application of standards pursuant to existing laws and regulations; risks related to dependence on key personnel; COVID-19 risks to employee health and safety and a slowdown or temporary suspension of operations in geographic locations impacted by an outbreak; estimates used in budgeting and financial statements proving to be incorrect; risks related to unforeseen delays in the review process including availability of personnel from the USFS, State of Idaho and other stated, federal and local agencies and regulatory bodies (including, but not limited to, future US government shutdowns); risks related to opposition to the Project; risks related to increased or unexpected costs in operations or the permitting process; risks that necessary financing will be unavailable when needed on acceptable terms, or at all; risks related to the outcome of litigation and potential for delay of the Project, as well as those factors discussed in the Company’s public disclosure record. Although the Company has attempted to identify important factors that could affect the Company and may cause actual actions, events or results to differ materially from those described in Forward-Looking Information, there may be other factors that cause actions, events or results not to be as anticipated, estimated or intended. There can be no assurance that Forward-Looking Information will prove to be accurate, as actual results and future events could differ materially from those anticipated in such statements. Because it is not possible to predict or identify all such factors, this list cannot be considered a complete set of all potential risks or uncertainties. Accordingly, readers should not place undue reliance on Forward-Looking Information. For further information on these and other risks and uncertainties that may affect the Company’s business and liquidity, see the “Risk Factors” and “Management’s Discussion and Analysis of Financial Condition and Results of Operations” sections of the Company’s filings with the SEC, are available at www.sec.gov and with the Canadian securities regulators, which are available at www.sedar.com. Except as required by law, the Company expressly disclaims any obligation to update the Forward-Looking Information herein.



CAUTIONARY NOTE & TECHNICAL DISCLOSURE

The presentation has been prepared by Perpetua Resources management and does not represent a recommendation to buy or sell these securities. Investors should always consult their investment advisors prior to making any investment decisions. All references to “dollars” or “\$” shall mean United States dollars unless otherwise specified.

The material scientific and technical information in respect of the Stibnite Gold Project in this presentation, unless otherwise indicated, is based upon information contained in the technical report titled “Stibnite Gold Project, Feasibility Study Technical Report, Valley County, Idaho” dated effective December 22, 2020 and issued January 27, 2021 (the “FS” or “2020 Feasibility Study”). The 2020 Feasibility Study was prepared in accordance with National Instrument 43-101 – Standards of Disclosure for Mineral Projects (“NI 43-101”). NI 43-101 is a rule developed by the Canadian Securities Administrators that establishes standards for all public disclosure an issuer makes of scientific and technical information concerning mineral projects. These standards differ from the mining property disclosure rules specified in Subpart 1300 of Regulation S-K under the United States Securities Act of 1933 (“Subpart 1300”) promulgated by the SEC. Accordingly, information concerning mineral deposits from the 2020 Feasibility Study set forth herein may not be comparable with information made public by companies that report in accordance with U.S. standards.

The Company has issued its inaugural Technical Report Summary (the “TRS”), dated as of December 31, 2021, and amended as of June 6, 2022, developed for the Stibnite Gold Project in accordance with the mining property disclosure rules specified in Subpart 1300 promulgated by the SEC. The TRS summarizes, in accordance with the mining property disclosure rules specified in Subpart 1300, the FS, which was completed under NI 43-101, with the following notable differences between the FS and the TRS:

- The TRS Mineral Resource estimates were developed based on a gold price of \$1,500/oz versus the \$1,250/oz gold price assumed for the FS. The change in gold price results from higher trailing average gold prices at the date of preparation for the respective reports.
- The Measured Mineral Resources in the FS were reclassified to Indicated Mineral Resources in the TRS due to differences in Subpart 1300 versus NI 43-101 Mineral Resources classification guidelines.
- The Proven Mineral Reserves from the FS were reclassified as Probable Mineral Reserves for the TRS resulting from the reclassification of the Measured Mineral Resources to Indicated Mineral Resources due to differences in Subpart 1300 versus NI 43-101 Mineral Resources classification guidelines.
- The TRS is classified as a Preliminary Feasibility level study whereas the FS was classified as a Feasibility level study. This change was driven by the Subpart 1300 requirement that a compliant Feasibility level TRS include a capital cost contingency allowance no greater than 10%, whereas the initial capital cost estimate for the FS included a more conservative allowance at approximately 15%.

All other technical analyses, design information, capital and operating cost information, economic analyses, permitting and legal assumptions, conclusions and recommendations are consistent between the TRS and the FS. Readers are encouraged to read the TRS and the Company’s Current Report on Form 8-K filed with the SEC on January 3, 2021, as amended by the Company’s Current Report on Form 8-K/A filed with the SEC on June 8, 2022, which are available under the Company’s profile on EDGAR. Readers are also encouraged to read the FS, which is available on the Company’s website and under the Company’s profile on SEDAR, for detailed information concerning the Project. See also “Regulatory Information” at the end of this presentation.

This presentation contains certain mineral reserve, production, costs, valuation, capitalization, trading data and similar information regarding certain other mineral projects and peer companies. Such data was derived from publicly available reports by such companies and other trade and industry sources. While the company believes such sources to be reliable, the company has not independently verified such information. Furthermore, information regarding mineral reserves, production and similar mineral project information for each company is based on estimates, assumptions and reporting standards applied to available data by each company and their reserve engineers in their respective reports, which may differ materially from the estimates, assumptions and reporting standards applied by us, and therefore may not be comparable among the companies presented. As a result, comparisons of such data made in this presentation, while considered reasonable at the time they are made, are subject to a variety of risks and uncertainties which could cause actual events or results of each company to differ materially from those reflected and there can be no assurance that we will be able to achieve similar results at similar stages of development.

Investors should be aware that the publication of the SDEIS and the permitting schedule, and the identification by the USFS of the Modified Mine Plan as the Preferred Alternative in the SDEIS, does not indicate any commitments on the part of the USFS with regard to the content or timing of a final decision. In developing the FEIS, the next phase of the NEPA planning process, the USFS may select various actions based on the Modified Mine Plan or each of the alternatives analyzed in the SDEIS. Furthermore, the USFS is not bound by the permitting schedule and anticipated milestones may be delayed materially or not be satisfied.



WHY PERPETUA RESOURCES?

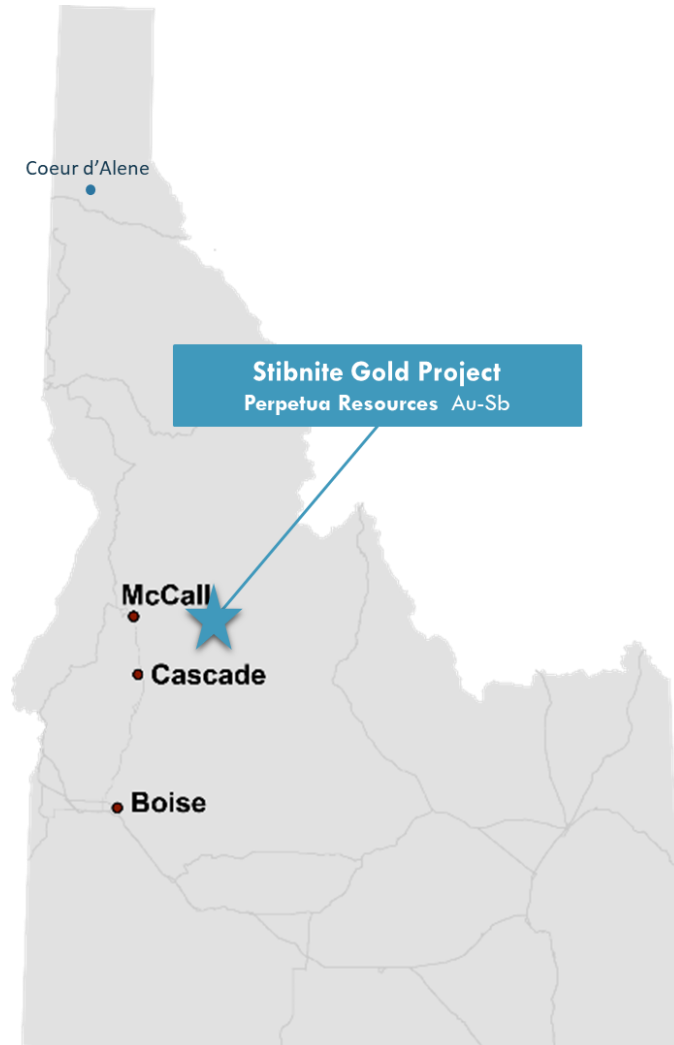

- ✓ Redeveloping one of **largest, highest grade** and **lowest cost** gold projects in the U.S.*
- ✓ **Superior project economics** with ~15 year reserve life and <3 year payback period*
- ✓ **Establishing a national strategic asset** with a **critical mineral** essential for national defense and the **clean energy transition**
- ✓ Located in **stable mining jurisdiction** with **Idaho community** and **political support**
- ✓ **Sustainable approach** to restoring the environment, improving a legacy, and creating value for all stakeholders
- ✓ **Attractive valuation** with **significant near-term catalysts**

**Based on the 2020 Feasibility Study ("FS") which is intended to be read as a whole and sections should not be read or relied upon out of context. The information in this presentation is subject to the assumptions, exclusions and qualifications contained in the FS. See "Regulatory Information" at the end of this presentation. For a summary of differences between the FS and TRS, see "Cautionary Note and Technical Disclosure" at the beginning of this presentation.*



THE STIBNITE GOLD PROJECT

Our goal is to transform an area abandoned after 100 years of mining activity into a national strategic asset for critical mineral and gold production through responsible mining and a sustainable approach to restore the environment for the benefit of all stakeholders.



LARGEST INDEPENDENT¹ U.S. GOLD RESERVE

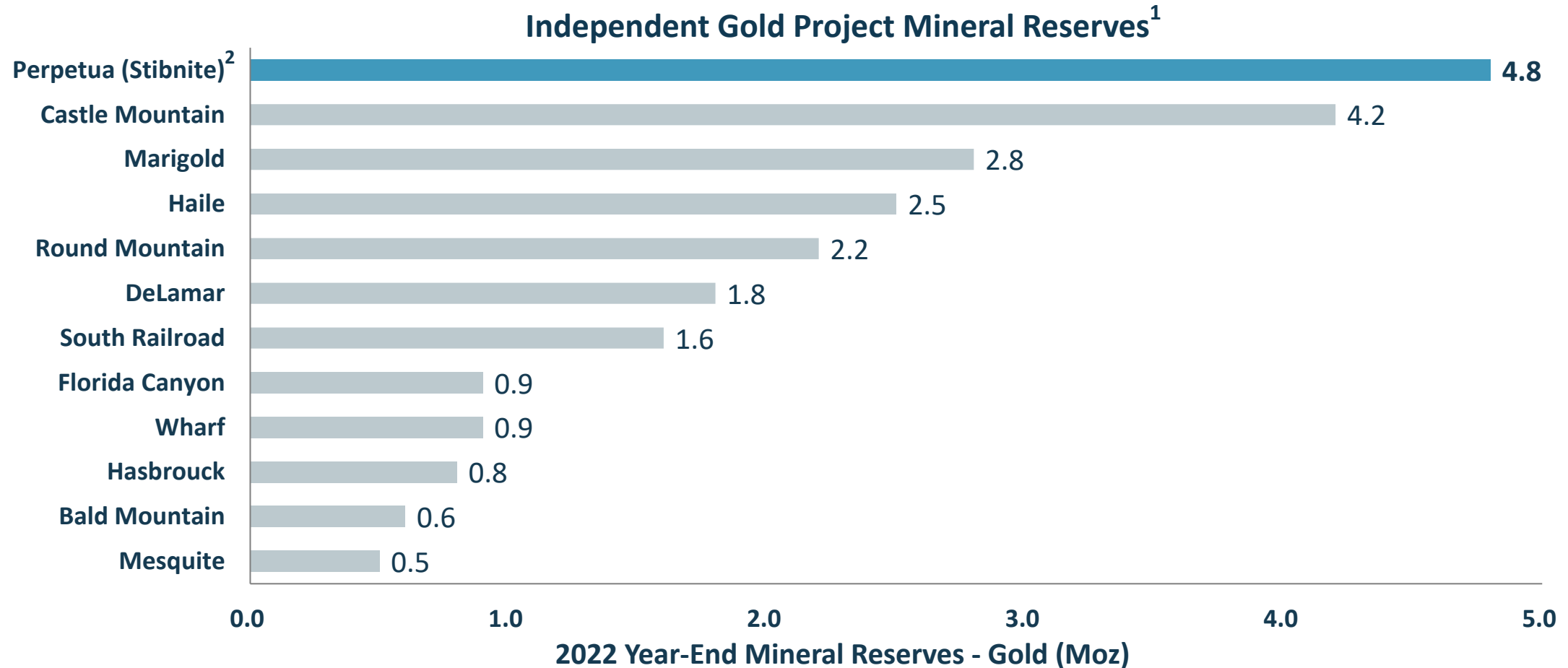

Source: Latest available company materials as of April 21, 2023

1. Independent refers to gold projects as not owned by Barrick or Newmont; Independent projects shown are from the lower 48 states in the U.S.

2. Based on the 2020 Feasibility Study (FS) which is intended to be read as a whole and sections should not be read or relied upon out of context. The information in this presentation is subject to the assumptions, exclusions and qualifications contained in the FS. See "Regulatory Information" at the end of this presentation. For a summary of differences between the FS and TRS, see "Cautionary Note and Technical Disclosure" at the beginning of this presentation.



HIGH-GRADE, OPEN PIT GOLD DEPOSIT

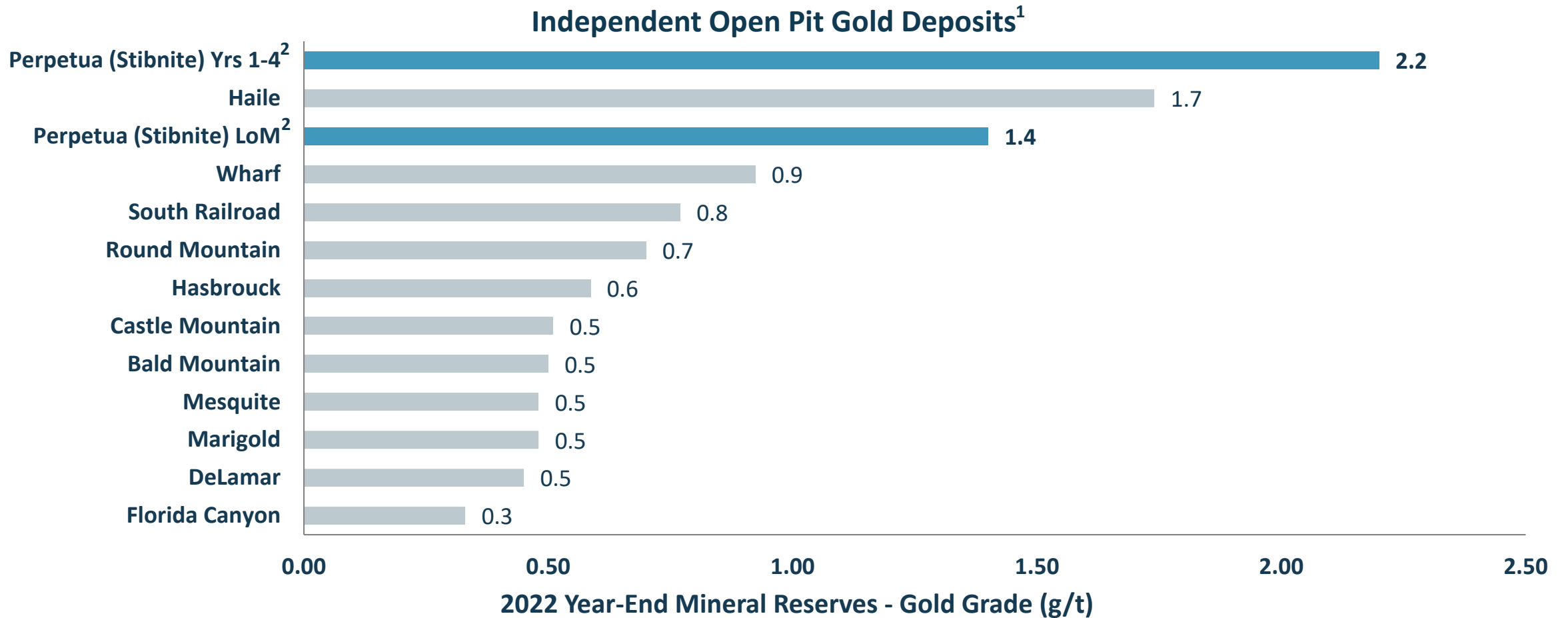

Source: Latest available company materials as of April 21, 2023

1. Independent refers to gold projects as not owned by Barrick or Newmont; Independent projects shown are from the lower 48 states in the U.S.

2. Based on the 2020 Feasibility Study (FS) which is intended to be read as a whole and sections should not be read or relied upon out of context. The information in this presentation is subject to the assumptions, exclusions and qualifications contained in the FS. See "Regulatory Information" at the end of this presentation. For a summary of differences between the FS and TRS, see "Cautionary Note and Technical Disclosure" at the beginning of this presentation.



POISED TO BE ONE OF LARGEST U.S. GOLD MINES

Independent Projects and Producing Gold Mines¹

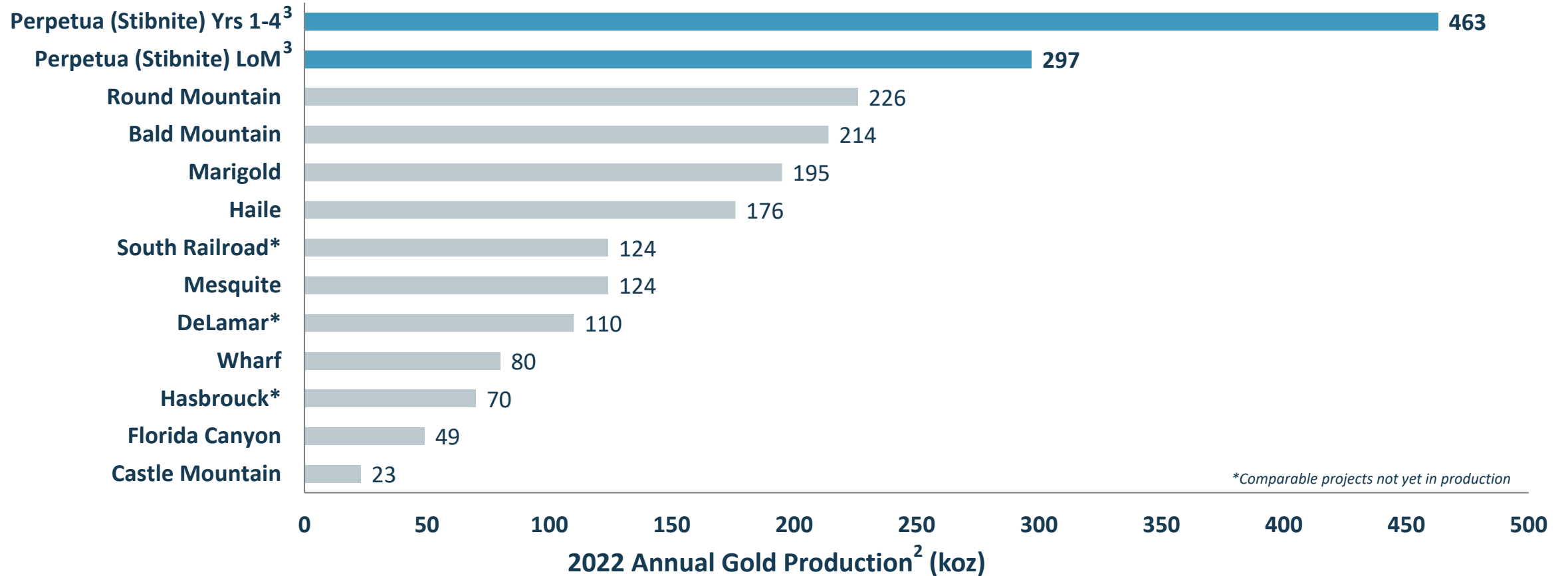

Source: Latest available company materials as of April 21, 2023

1. Independent refers to gold projects as not owned by Barrick or Newmont; Independent projects shown are from the lower 48 states in the U.S.

2. 2022 annual gold production for the peer group producing mines; future life-of-mine average annual production for the South Railroad, DeLamar, and Hasbrouck projects based on the most recent technical studies available; Perpetua (Stibnite) is based on estimated future production from the 2020 Feasibility Study.

3. Based on the 2020 Feasibility Study (FS) which is intended to be read as a whole and sections should not be read or relied upon out of context. The information in this presentation is subject to the assumptions, exclusions and qualifications contained in the FS. See "Regulatory Information" at the end of this presentation. For a summary of differences between the FS and TRS, see "Cautionary Note and Technical Disclosure" at the beginning of this presentation.



LOWEST QUARTILE ALL-IN SUSTAINING COSTS¹

Among lowest cost North American developers...

...and lowest cost relative to senior producers

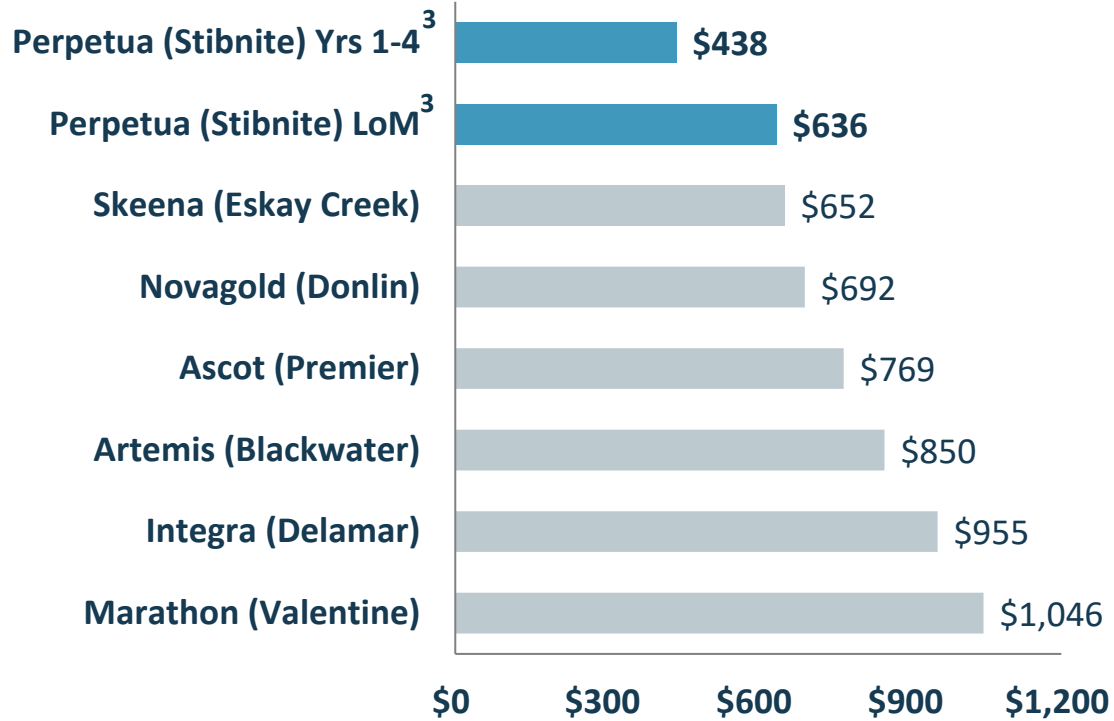

North American Gold Developer All-in Sustaining Costs (\$/oz)^{1,2}



North American Senior Gold Producer All-in Sustaining Costs (\$/oz)^{1,2}

Valuable antimony by-product credit of \$70/oz over life of mine³

1. All-in Sustaining Cost ("AISC") is a non-GAAP measure. See "Non-GAAP measures" at the end of this presentation.
 2. North American gold developer project all-in sustaining costs are based on the most recent available technical reports. North American senior gold producer all-in sustaining costs represent FY 2022 actuals from company reports and filings.
 3. Based on the 2020 Feasibility Study (FS) which is intended to be read as a whole and sections should not be read or relied upon out of context. The information in this presentation is subject to the assumptions, exclusions and qualifications contained in the FS. See "Regulatory Information" at the end of this presentation. For a summary of differences between the FS and TRS, see "Cautionary Note and Technical Disclosure" at the beginning of this presentation. Antimony by-product credit is calculated using antimony price of \$3.50/lb.



SIGNIFICANT LEVERAGE TO HIGHER GOLD PRICES

TRADING AT DEEP DISCOUNT TO PROJECT NET PRESENT VALUE¹

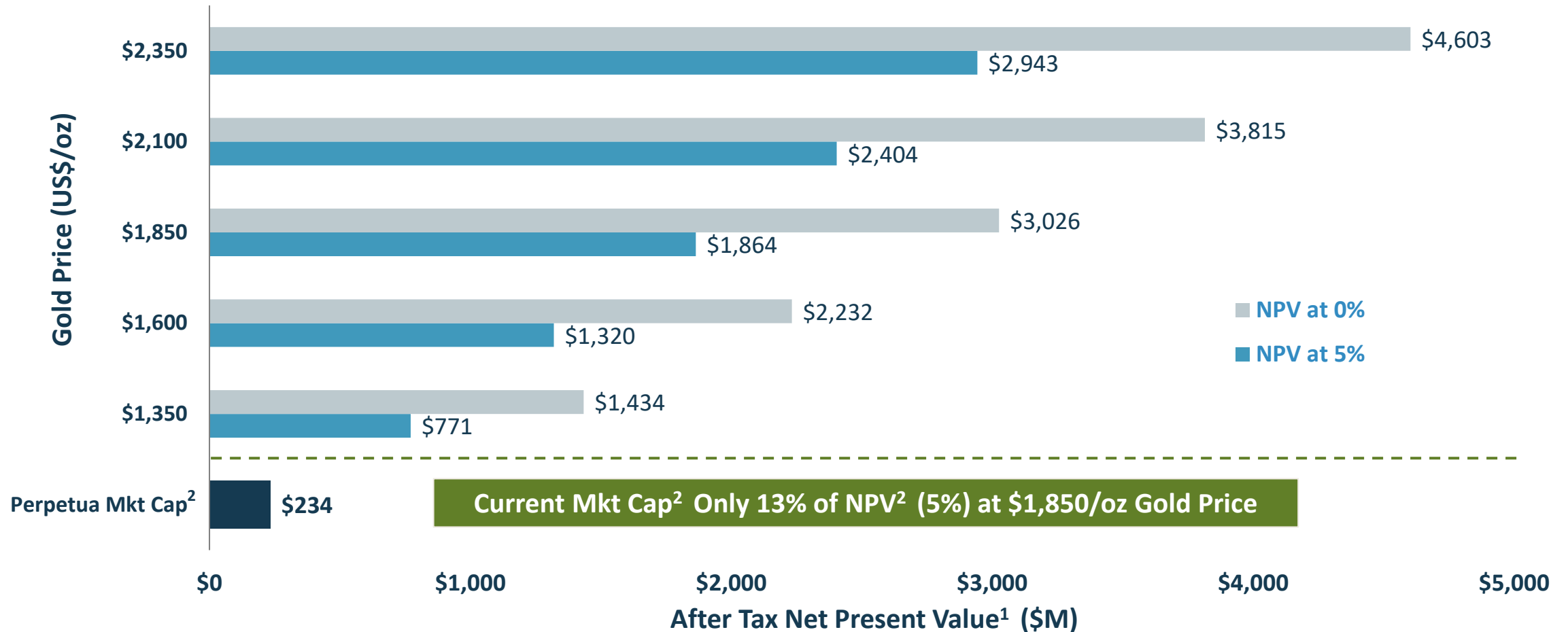

1. Based on the 2020 Feasibility Study (FS) which is intended to be read as a whole and sections should not be read or relied upon out of context. The information in this presentation is subject to the assumptions, exclusions and qualifications contained in the FS. See "Regulatory Information" at the end of this presentation. For a summary of differences between the FS and TRS, see "Cautionary Note and Technical Disclosure" at the beginning of this presentation.

2. Perpetua Resources market cap based on fully diluted market cap using closing price as of August 4, 2023 (US\$3.53 share price and fully diluted shares of 66 million)



ESTABLISHING A NATIONAL STRATEGIC ASSET

ANTIMONY - IT'S CRITICAL

- ✓ Essential to economic and national security
- ✓ U.S. has no domestic mined production
- ✓ Clean energy & national defense applications
- ✓ China & Russia dominate the world supply (>70%)

USES FOR ANTIMONY



World Antimony 2022 Production (USGS)

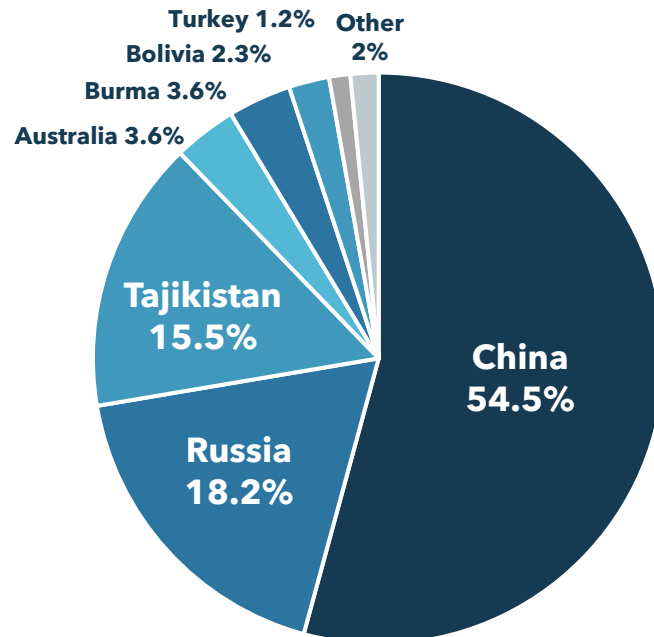

Other countries that produce less than 1% of global supply:
Mexico, Iran, Vietnam, Kazakhstan, Guatemala, Pakistan, Canada



EXPECTED TO AVERAGE ~35% OF U.S. DEMAND^{1,2}

Stibnite Gold Project Recovered Antimony²

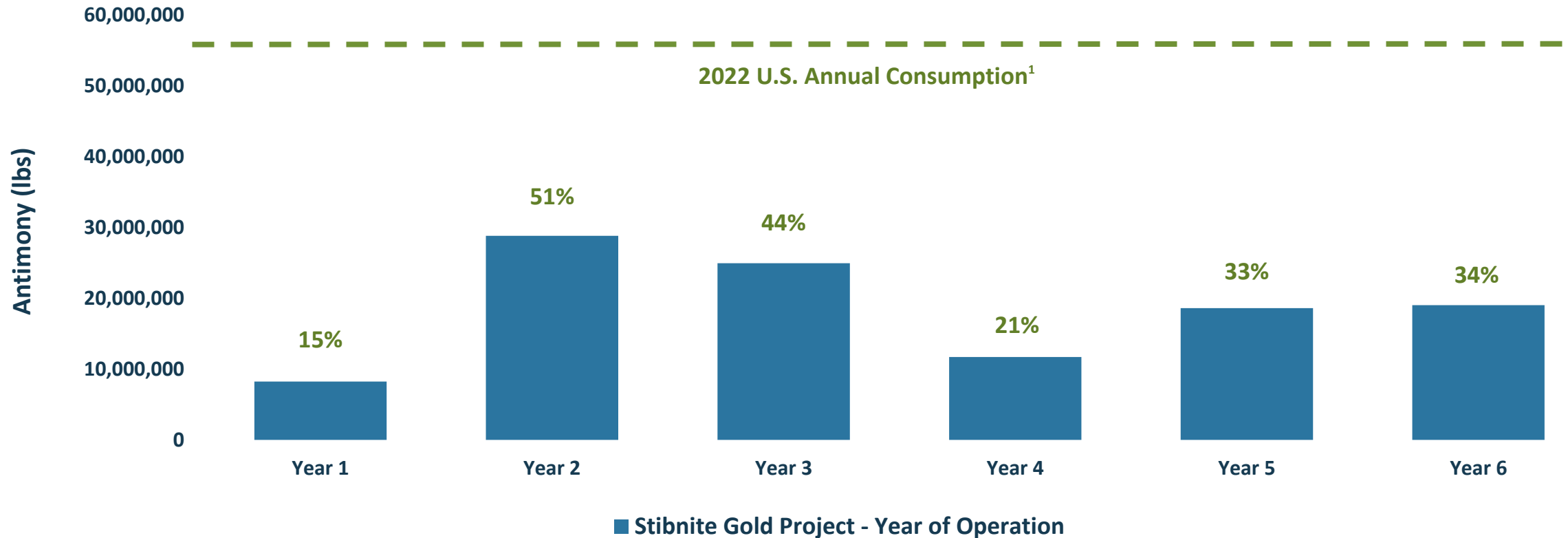

Perpetua Resources plans to re-establish domestic antimony production, protecting America's future

1. Source: 2023 USGS Antimony commodity summary
2. Based on the 2020 Feasibility Study (FS) which is intended to be read as a whole and sections should not be read or relied upon out of context. The information in this presentation is subject to the assumptions, exclusions and qualifications contained in the FS. See "Regulatory Information" at the end of this presentation. For a summary of differences between the FS and TRS, see "Cautionary Note and Technical Disclosure" at the beginning of this presentation.



DEFENSE PRODUCTION ACT (DPA) AWARD

Critical minerals award of \$24.8 million to advance construction readiness and permitting

- ✓ **\$24.8 million** to complete environmental and engineering studies necessary to obtain a Final EIS, Final Record of Decision and other ancillary permits
- ✓ Funding allows Perpetua to **advance the construction readiness of the Stibnite Gold Project** while the company continues through permitting
- ✓ The investment is **essential to ensure the timely development** of a domestic source of antimony trisulfide
- ✓ Site provided 90% of U.S. antimony supplies during World War II and the Korean War and today the project holds an **antimony resource of over 200 million pounds**
- ✓ **First critical minerals award** using Ukraine Supplemental Appropriations funds to secure an American source of antimony for missiles and munitions

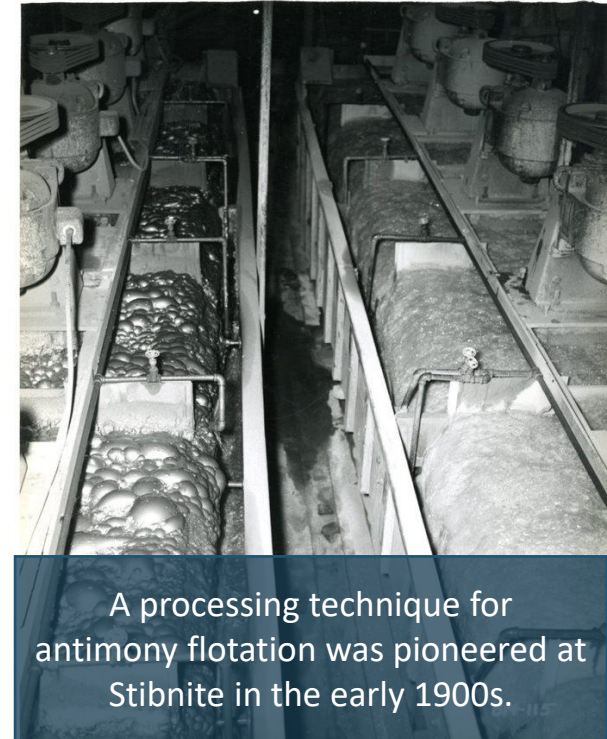

“This action reinforces the Administration’s goals to increase the resilience of our critical mineral supply chains while deterring adversarial aggression.”

- Halimah Najieb-Locke, Deputy Assistant Secretary of Defense for Industrial Base Resilience



PERPETUA TO POWER AMBRI'S LOW-COST BATTERY

Agreement to supply only responsible & domestically mined source of antimony for stationary, long duration, daily cycle energy storage enabling the transition to cleaner energy

SUPPLY AGREEMENT¹:

- Current commitment of Perpetua's antimony can power over 13 GWh of energy storage or >8x the total additions to entire U.S. energy storage market in 2020
- Based on standard commercial terms with options for fixed pricing and higher volumes
- Partnering with Ambri to identify opportunities to reduce carbon emissions in operations through renewable energy combined with battery storage

Ambri secured \$144M from Reliance Industries, Paulson & Co., Bill Gates and others to accelerate growth and recently announced a tripling of its manufacturing capacity in the U.S.

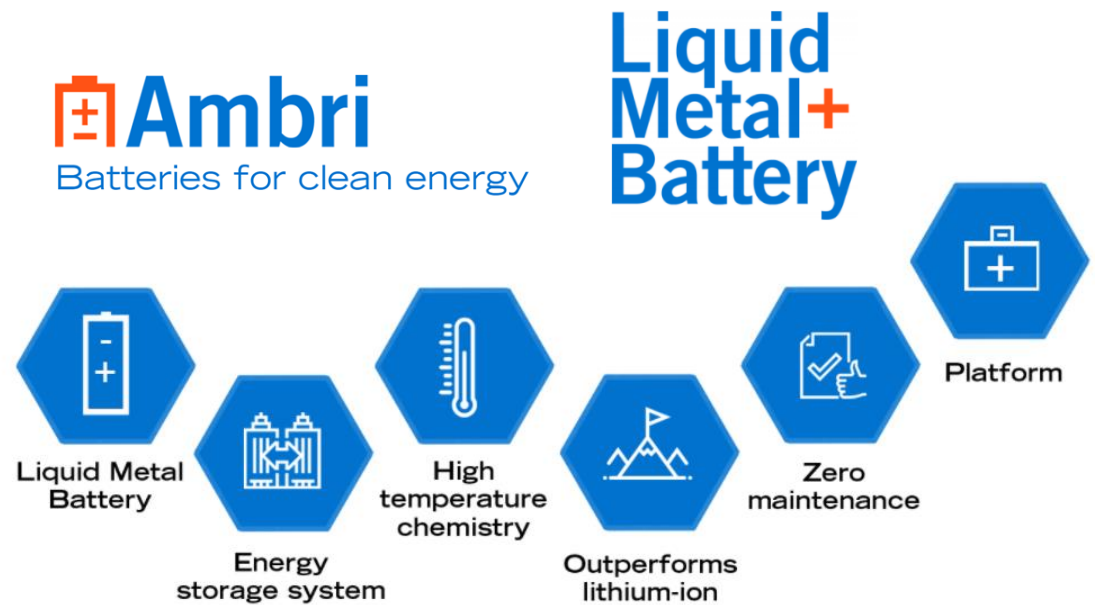

Source: <https://ambri.com/>

Redefining how modern mining companies can be part of climate change solutions

1. Subject to completion of the permitting process for the Project, commencement of commercial production of antimony, identification of one or more refiners to transform our antimony concentrate into antimony metal, and mutual agreement on certain material terms, including volume and pricing. For additional information regarding the risks and uncertainties surrounding our supply agreement with Ambri, see "Forward-Looking Statements" at the beginning of this presentation.



RESTORING AN ABANDONED BROWNFIELDS SITE

ENVIRONMENTAL SOLUTIONS FUNDED THROUGH MINE DEVELOPMENT

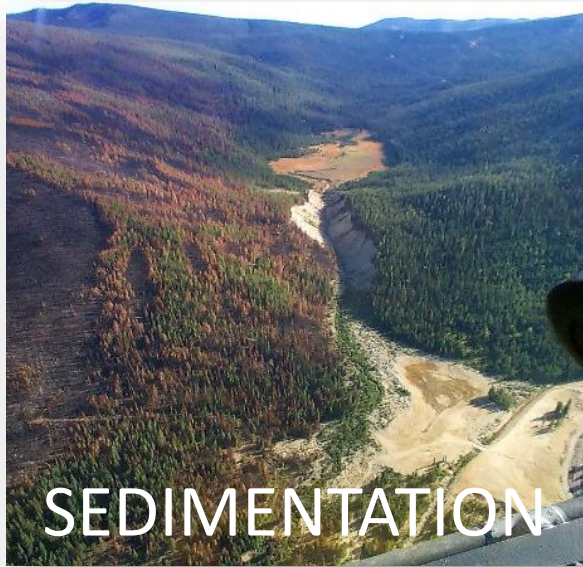

Early repair of the largest source of sedimentation



Pick up, reprocess, reuse and safely store 10.5M tons of tailings and spent ore



Re-establish fish migration and provide temporary and permanent river restoration



PATH FORWARD FOR THE STIBNITE GOLD PROJECT¹

U.S. Forest Service identified Perpetua's Proposed Plan as Preferred Alternative² in Supplemental EIS

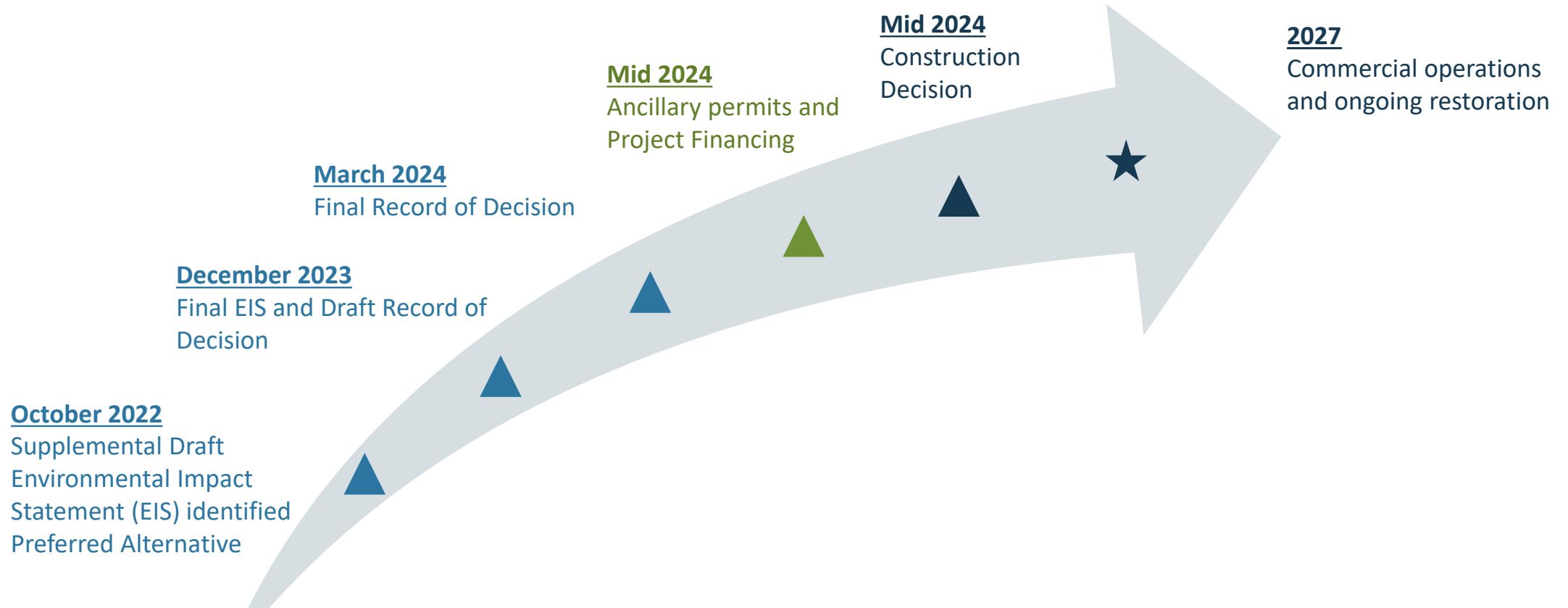

Preferred Alternative a major milestone providing clarity for remainder of the NEPA process

¹ See forward-looking statements at the beginning of this presentation. Based on USFS schedule published in March 2023.

² Under NEPA, a "Preferred Alternative" is identified by a Federal Agency in a DEIS to let the public know which action the agency is leaning toward selecting as final.

GAINING MOMENTUM WITH NEAR-TERM CATALYSTS



Recent Accomplishments:

- ✓ Awarded Department of Defense SBIR funding (Sep 2022)
- ✓ Supplemental Draft EIS published (Oct 2022)
- ✓ Awarded \$24.8 million under Defense Production Act (Dec 2022)
- ✓ Supplemental Draft EIS comment period closed (Jan 2023)
- ✓ Added to the Russell 2000® Index (Jun 2023)
- ✓ Began 2023 legacy cleanup activities (Jun 2023)
- ✓ Clean Water Act Settlement Agreement filed (Aug 2023)

Anticipated Milestones¹:

- ❑ Final Environmental Impact Statement & Draft Record of Decision (Dec 2023)²
- ❑ Final Record of Decision (Mar 2024)²
- ❑ Ancillary permits & financing (mid 2024)
- ❑ Construction, legacy restoration (summer 2024)
- ❑ Commercial operations, ongoing restoration (2027)

¹ See forward-looking statements at the beginning of this presentation

² Based on USFS schedule published in March 2023.

VALUATION EXPECTED TO RE-RATE ONCE PERMITTED

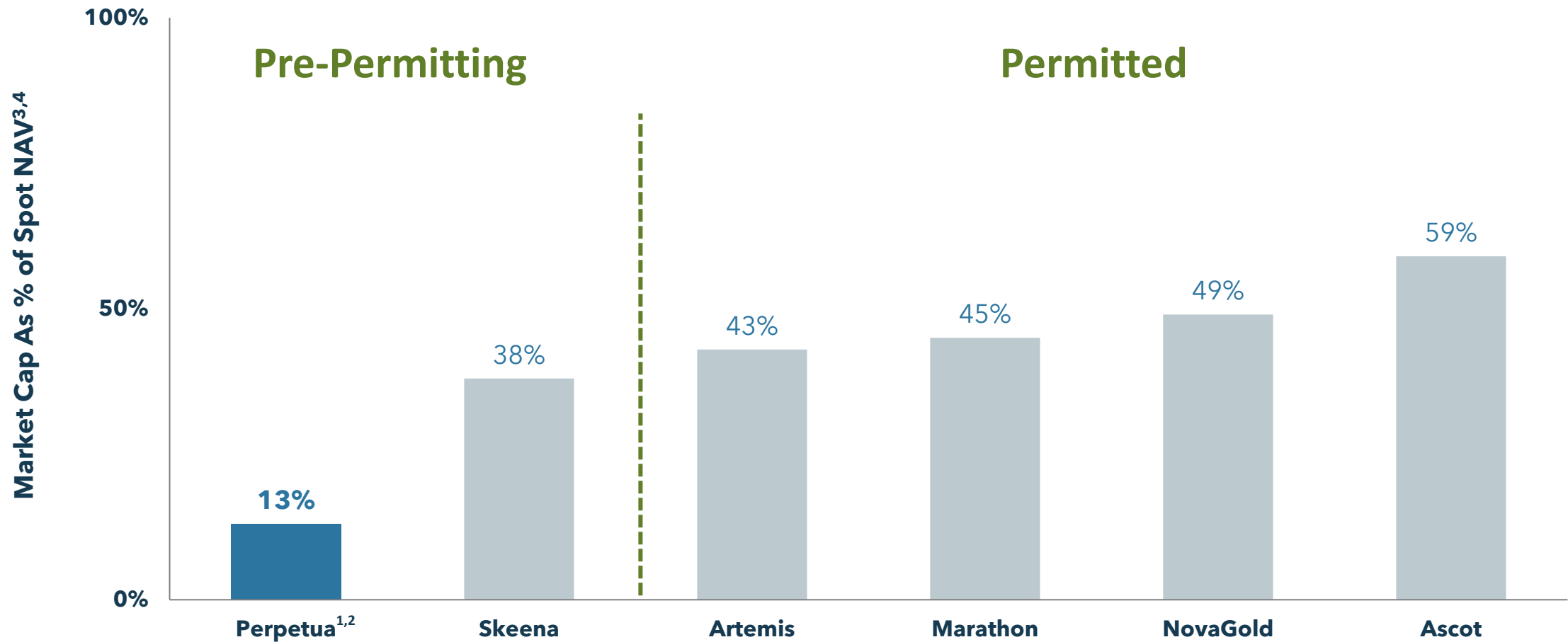

1. Perpetua Resources market cap based on fully diluted market cap using closing price as of August 4, 2023 (US\$3.53 share price and fully diluted shares of 66 million)

2. Based on the 2020 Feasibility Study (FS) which is intended to be read as a whole and sections should not be read or relied upon out of context. The information in this presentation is subject to the assumptions, exclusions and qualifications contained in the FS. See "Regulatory Information" at the end of this presentation. For a summary of differences between the FS and TRS, see "Cautionary Note and Technical Disclosure" at the beginning of this presentation.

3. NAV's based on after-tax NPV (5% discount rate) based on last available NAV within \$1,850/oz gold price.

4. Market Caps based on August 4, 2023 closing stock prices.



EXPOSURE TO GOLD AT ATTRACTIVE ENTRY PRICE

Leading Gold Reserves per share...

...at an attractive price per gold Reserve ounce

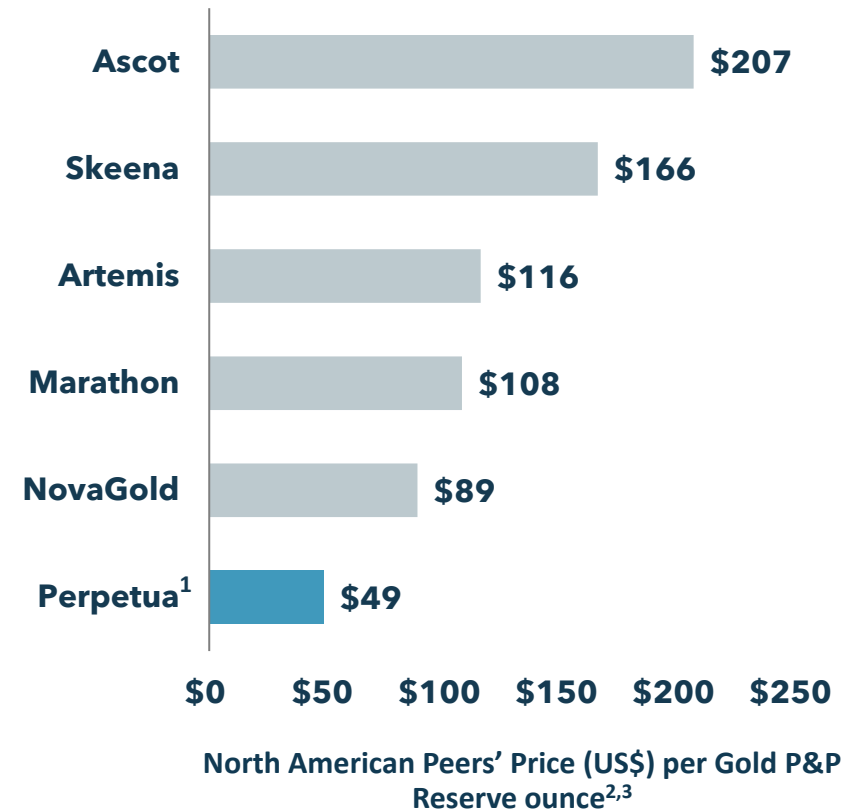
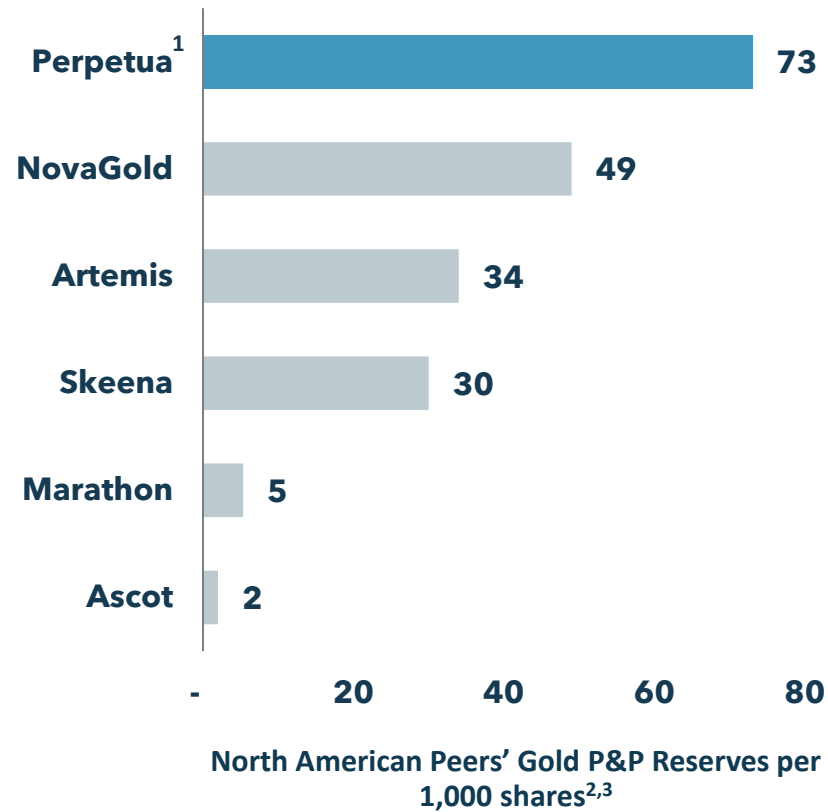

1. Based on the 2020 Feasibility Study (FS) which is intended to be read as a whole and sections should not be read or relied upon out of context. The information in this presentation is subject to the assumptions, exclusions and qualifications contained in the FS. See "Regulatory Information" at the end of this presentation. For a summary of differences between the FS and TRS, see "Cautionary Note and Technical Disclosure" at the beginning of this presentation.

2. North American peer Proven & Probable (P&P) gold Reserve ounces are based on the most recent available technical reports and company materials.

3. Per share metrics are presented on a fully diluted basis using publicly available information; market caps as of August 4, 2023 close prices, converted to U.S. dollars using the Bank of Canada exchange rate as of August 3, 2023.



A UNIQUE AMERICAN OPPORTUNITY



- ✓ Redeveloping one of **largest, highest grade** and **lowest cost** gold projects in the U.S.*
- ✓ **Superior project economics** with ~15 year reserve life and <3 year payback period*
- ✓ **Establishing a national strategic asset** with a **critical mineral** essential for national defense and the **clean energy transition**
- ✓ Located in **stable mining jurisdiction** with **Idaho community** and **political support**
- ✓ **Sustainable approach** to restoring the environment, improving a legacy, and creating value for all stakeholders
- ✓ **Attractive valuation** with **significant near-term catalysts**

**Based on the 2020 Feasibility Study (FS) which is intended to be read as a whole and sections should not be read or relied upon out of context. The information in this presentation is subject to the assumptions, exclusions and qualifications contained in the FS. See "Regulatory Information" at the end of this presentation. For a summary of differences between the FS and TRS, see "Cautionary Note and Technical Disclosure" at the beginning of this presentation.*



**Perpetua
Resources**
CORP.

Appendix



DIVERSE, EXPERIENCED LEADERSHIP TEAM

EXECUTIVE TEAM



Laurel Sayer
Board Director & CEO



Jessica Largent
Chief Financial Officer



Mckinsey Lyon
VP, External Affairs



Alan Haslam
VP, Permitting

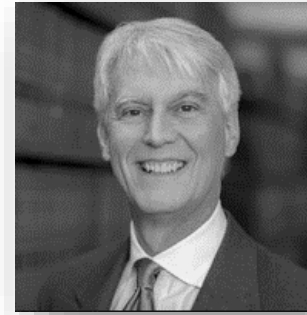

Michael Bogert
General Counsel



Tanya Nelson
VP, Human Resources

CORPORATE BOARD



Marcelo Kim
Chairman
Paulson & Co



Bob Dean
Director
Former Allen & Company

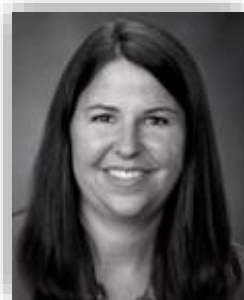

Laura Dove
Director
Former Ford Motor Company, Secretary for the Majority of the U.S. Senate



Rich Haddock
Director
Former Barrick



Jeff Malmen
Director
Idaho Power, Former Chief of Staff Governor Otter



Chris Papagianis
Director
Hudson Bay Capital



Chris Robison
Director
Former Newmont, Rio Tinto Minerals & Kennecott Utah Copper



Alex Sternhell
Director
Sternhell Group, Democrat Dpty. Staff Director US Senate Cm. Banking



IDAHO: A PREMIER MINING JURISDICTION

- Well-defined Permitting Process
- Substantial **Community and Political Support**
- **Low** Geopolitical Risk
- Strong **infrastructure & low-cost power**
- Talented & experienced workforce

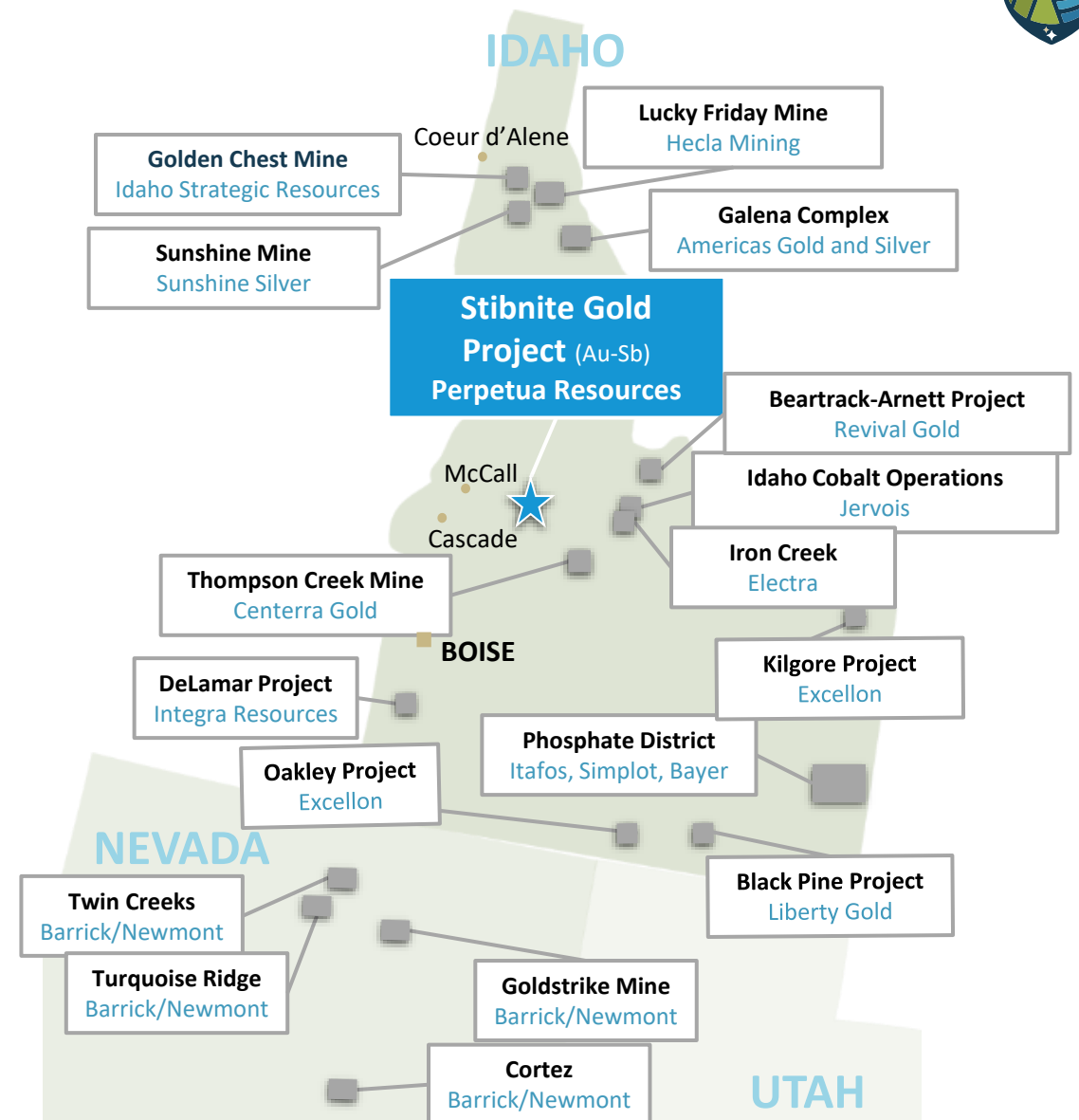



CHANGING THE FACE OF MINING



STRONG ENVIRONMENTAL, SOCIAL & GOVERNANCE PRINCIPLES BUILT INTO CORE BUSINESS PLANS

- ✓ Community Agreement signed in 2018
- ✓ Adopted ESG policy in 2019
- ✓ Annual Sustainability Reporting
- ✓ 60k+ Trees Planted
- ✓ 104+ Months No Reportable Spills
- ✓ Dark Skies commitments
- ✓ Launched Sustainability Roadmap in 2022
- ✓ Installed solar power to reduce current reliance on fuel



Note: Numbers reflect Perpetua Resources Idaho, Inc. staff and board members as of January 2022



IMPROVING A LEGACY

PLAN DESIGNED WITH POST MINING RESTORATION GOALS IN MIND, INCLUDING WILDLIFE, FISHERIES & DISPERSED RECREATION

- Create a self-sustaining natural environment
- Support healthy fish and wildlife population
- Significant concurrent reclamation & restoration
- Revegetation, reforestation & wetland mitigation
- Address historical impacts from legacy mining
- 10+ year post-operations closure period
- 25 years of water treatment estimated

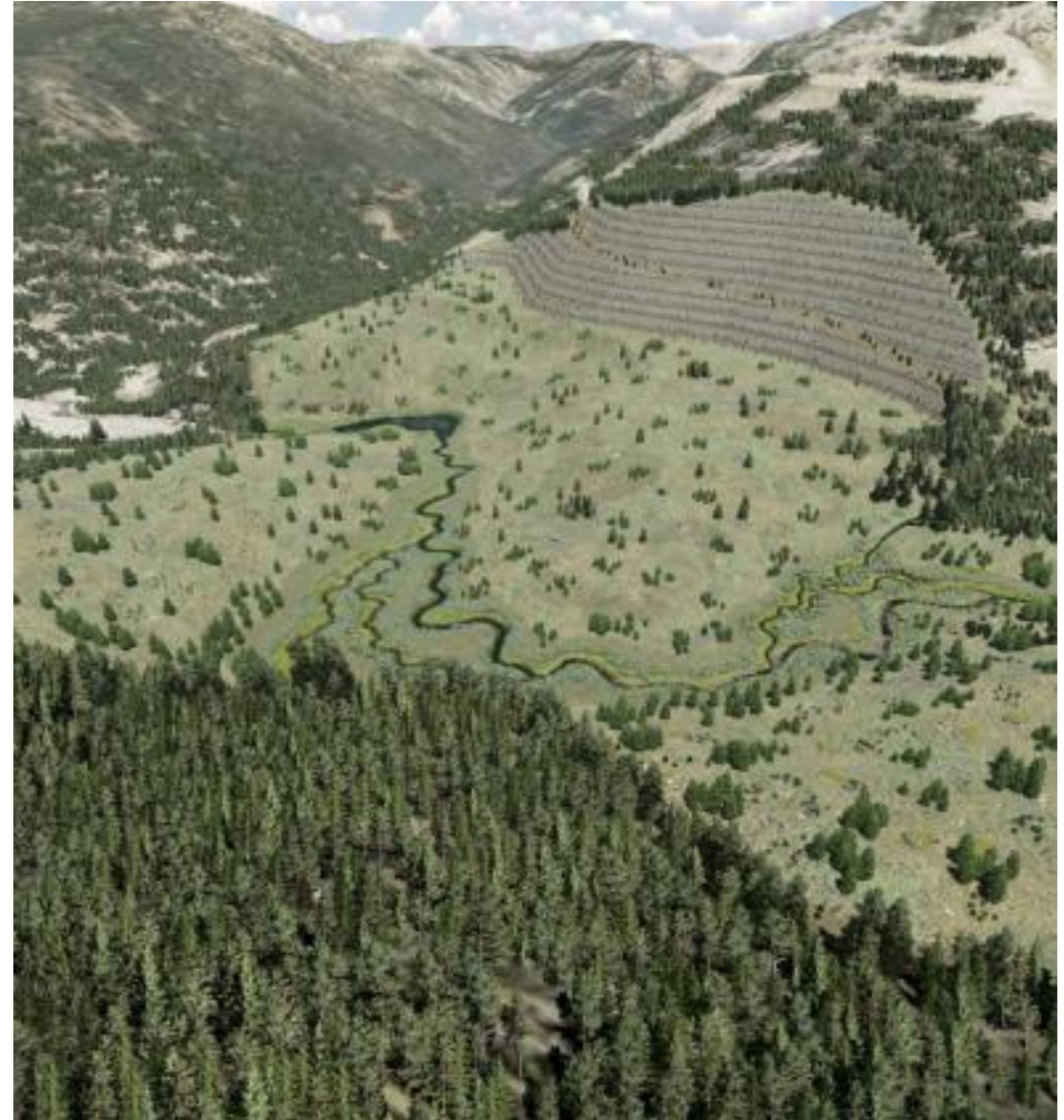

Based on the 2020 Feasibility Study (FS) which is intended to be read as a whole and sections should not be read or relied upon out of context. The information in this presentation is subject to the assumptions, exclusions and qualifications contained in the FS. See "Regulatory Information" at the end of this presentation. For a summary of differences between the FS and TRS, see "Cautionary Note and Technical Disclosure" at the beginning of this presentation. See the section titled "Forward-Looking Statements" at the beginning of this presentation.



ANTIMONY-BASED LIQUID METAL BATTERIES

ABOUT AMBRI:

- Combining technological innovation with commercial application to store energy longer, in a scalable way that will change the way power grids operate
- Low-cost battery comprised of a liquid calcium alloy anode, a molten salt electrolyte and a cathode comprised of solid particles of antimony
- Ambri secured \$144M in capital led by Reliance New Energy Solar (Reliance Industries), Paulson & Co., Bill Gates, Fortistar, Goehring & Rozencwajg and Japan Energy Fund to accelerate growth and build domestic manufacturing facility
- Reliance appointed JV Partner in India as part of broader plans to invest \$10B billion in Green Energy Giga Complex

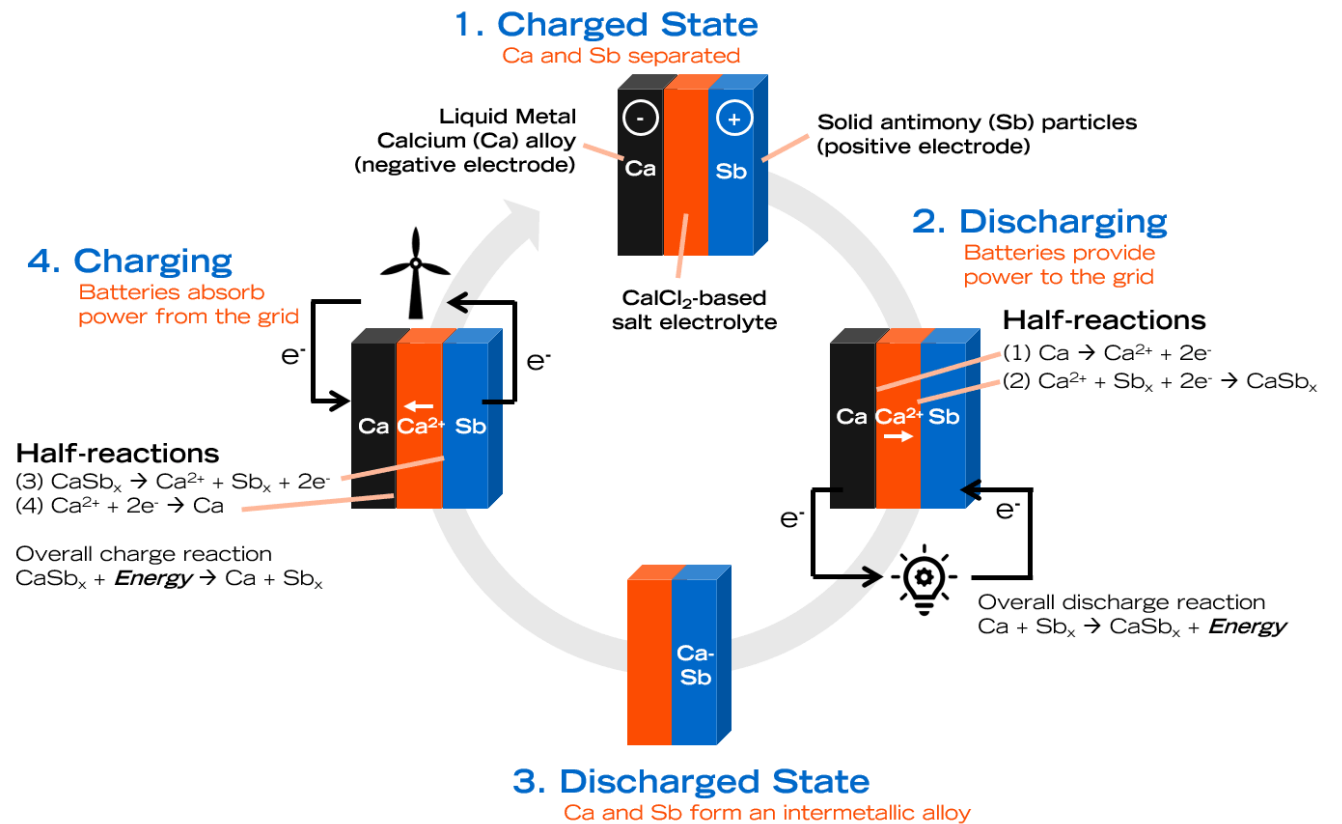

Source: <https://ambri.com/>



PERMITTING – NEXT STEPS



EIS: Environmental Impact Statement
DEIS: Draft Environmental Impact Statement
FEIS: Final Environmental Impact Statement

NOA: Notice of Availability
PRO: Plan of Restoration and Operations
ROD: Record of Decision



NEPA SCOPE NARROWED FOLLOWING SDEIS¹

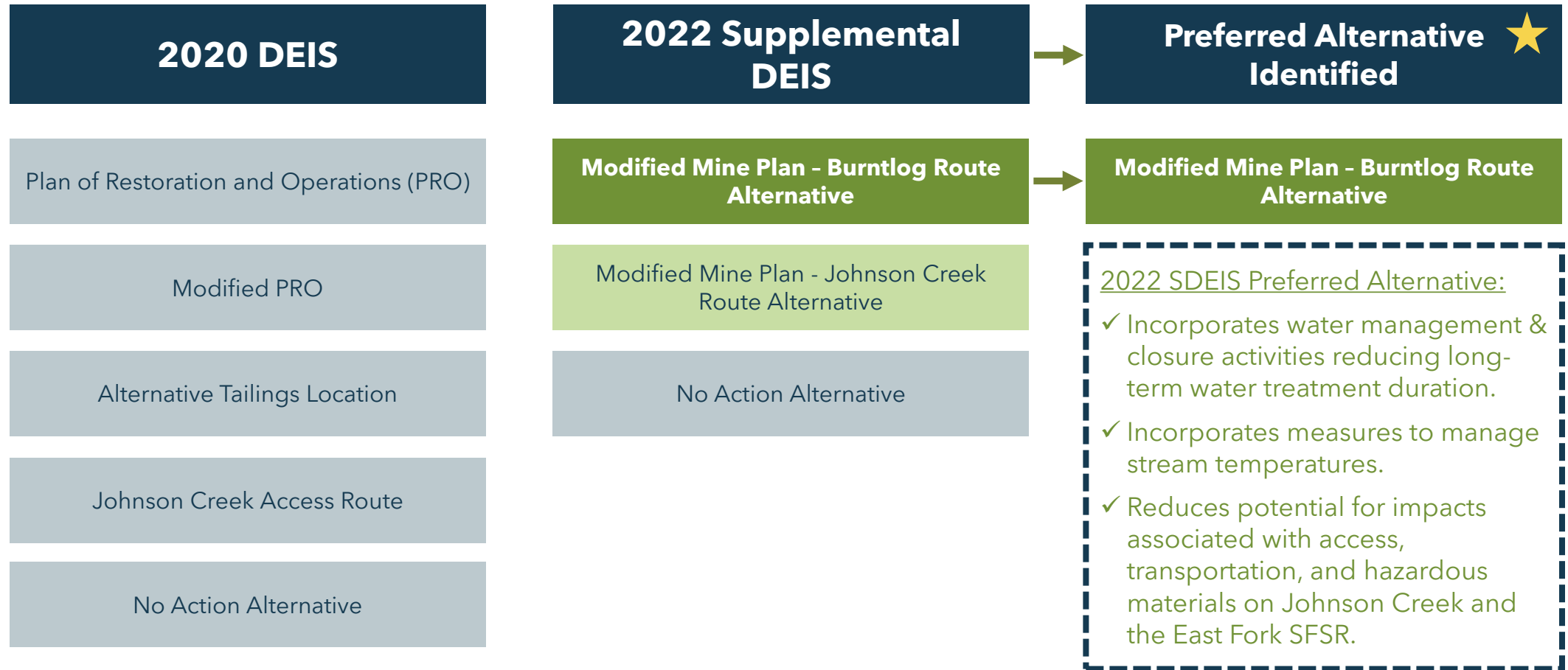

Perpetua's Proposed Plan identified as Preferred Alternative in Supplemental Draft EIS

¹ Under NEPA, a "Preferred Alternative" is identified by a Federal Agency in a DEIS to let the public know which action the agency is leaning toward selecting as final.



MINERAL RESOURCES & RESERVES¹

Proven & Probable Mineral Reserves²:

4.8 Mozs Gold @1.43 g/t

148 Mlbs antimony at 0.06% contained in 104 Mt

Measured & Indicated Mineral Resources³:

6.0 Mozs Gold @1.42g/t

206 Mlbs antimony at 0.07% contained in 132 Mt

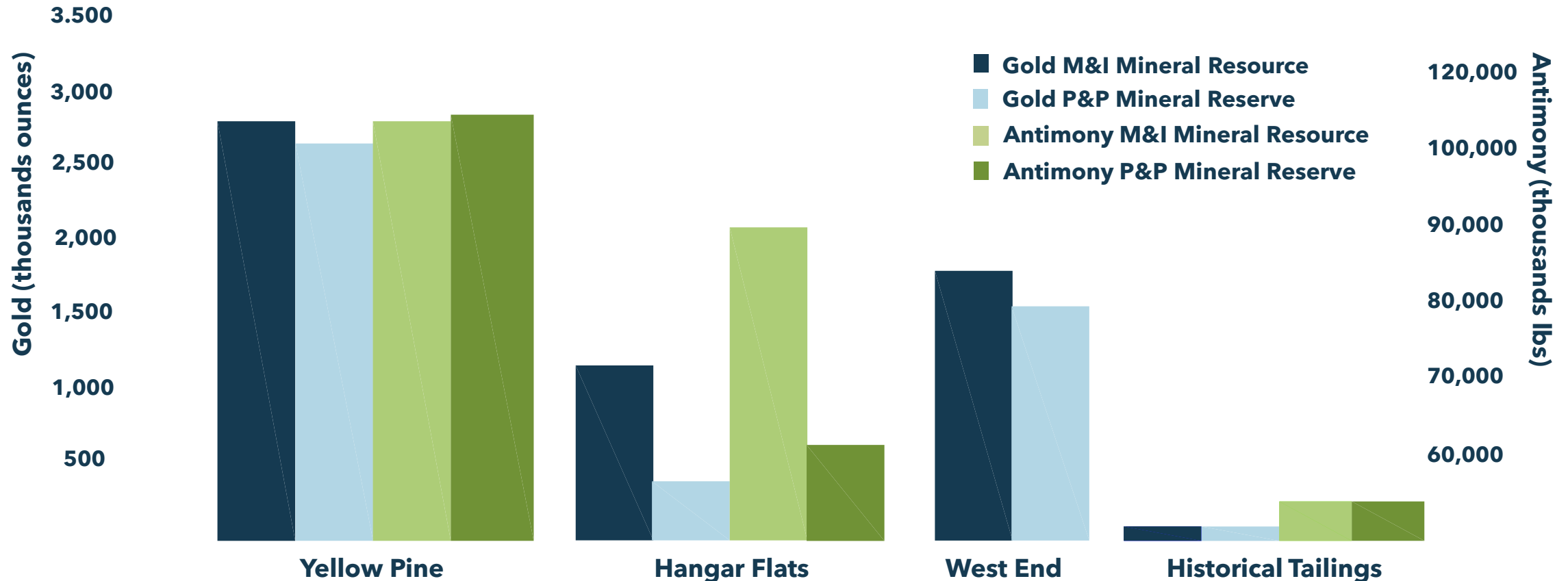

¹ Based on the 2020 Feasibility Study (FS) which is intended to be read as a whole and sections should not be read or relied upon out of context. The information in this presentation is subject to the assumptions, exclusions and qualifications contained in the FS. See "Regulatory Information" at the end of this presentation. For a summary of differences between the FS and TRS, see "Cautionary Note and Technical Disclosure" at the beginning of this presentation. The Mineral Reserves are contained within the Mineral Resources.

² Mineral Reserves were calculated using an Au price of \$1600/oz and Sb price of \$3.50/lb and variable cut off grade of 0.39-0.49 g/t Au. The Proven Mineral Reserves from the 2020 FS were reclassified as Probable Mineral Reserves for the TRS.

³ Mineral Resources were calculated using a \$1250/oz Au price and sulfide cut off grade of 0.45 g/t Au and oxide COG of 0.4 g/t Au based on the 2020 Feasibility Study. Based on a gold price of \$1,500/oz in the TRS, Mineral Resources increased to 6.3Mozs @1.33 g/t using a sulfide cut off grade of 0.40 g/t Au and oxide cut off grade of 0.35 g/tAu. The Measured Mineral Resources from the 2020 FS were reclassified to Indicated Mineral Resources in the TRS due to differences in the S-K 1300 versus NI 43-101 Mineral Resources classification guidelines.



EXPLORATION UPSIDE*

EXPANSIVE LAND PACKAGE

EXISTING DEPOSITS:

- Northeast of Yellow Pine Deposit
- Below Hangar Flats pit & Old Defense Minerals Exploration Act (DMEA) working area
- West End along strike and at depth

PRIORITY EXPLORATION TARGETS:

- High grade targets (Garnet, Scout, Upper Midnight)
- Bulk tonnage targets (Cinnamid-Ridgetop, Saddle-Fern, Rabbit)
- Undefined airborne targets (Mule, Salt & Pepper, Blow-out)

PIPELINE OF ANTIMONY-RICH TARGETS

** Some of the prospects are conceptual in nature, there has been insufficient exploration to define a mineral resource and it is uncertain if further exploration will result in the target being delineated as a mineral resource. See the section titled "Forward-Looking Statements" at the beginning of this presentation.*

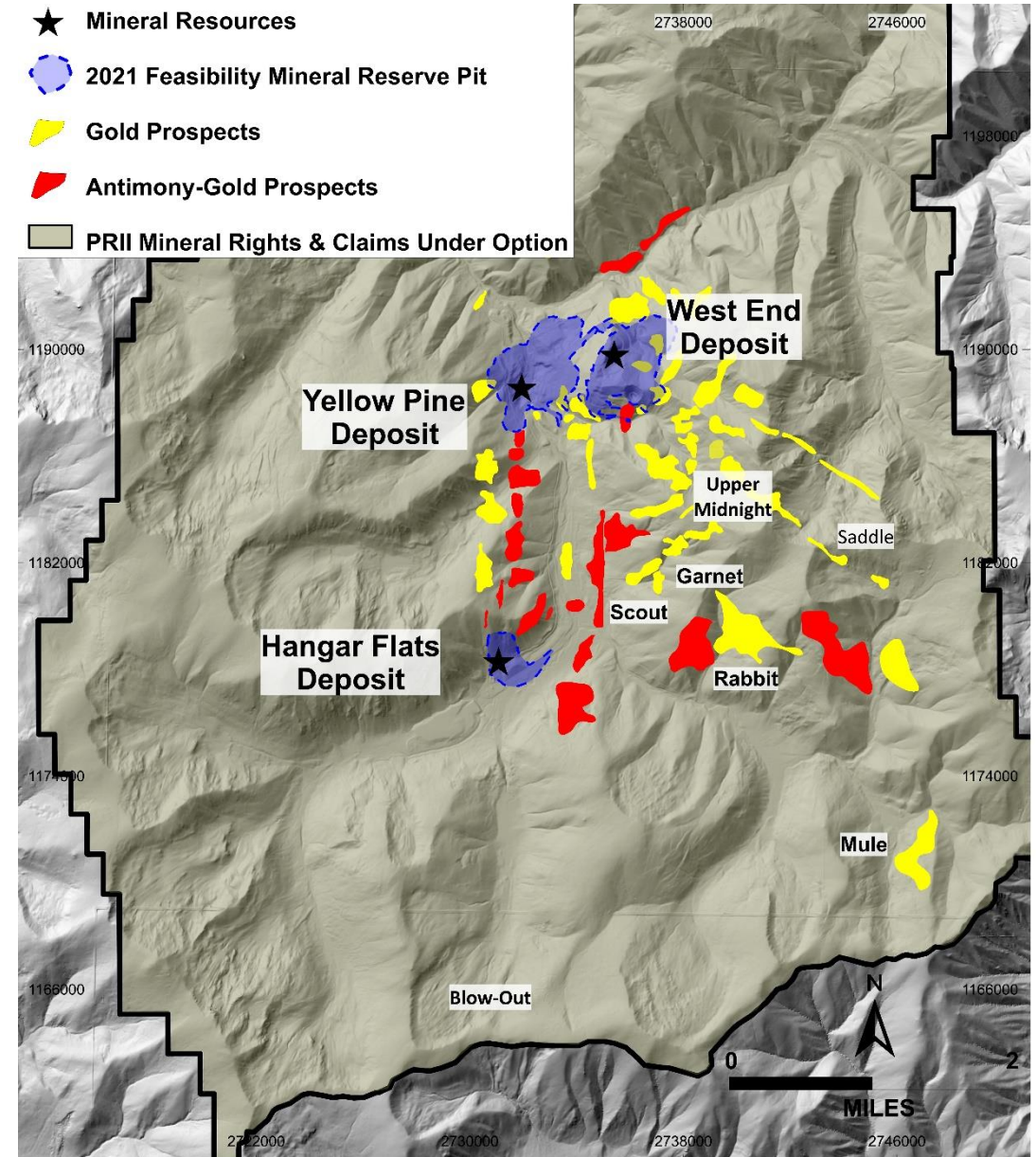



ORE PROCESSING

FLOW SHEET

Dore metallurgical recoveries

- Gold at 68% - 91% (88.9% average)
- Silver at 23.2% Average

Antimony concentrate metallurgical recoveries^{1, 2}

- Antimony at 84% - 91% (89.5% average)
- Gold at 1% - 2%
- Silver at 59% - 65%

High-grade antimony concentrate (Sb 55-65%)

- Low levels of impurities = no penalties

Gold and silver likely by-product payables in Sb concentrates

Potential Antimony processing options include

- Conventional pyrometallurgical (smelting and roasting)
- Hydrometallurgical (solvent extraction)
- Bench and pilot scale testing indicates both options are viable processes for Sb concentrates.

¹ reporting LOM averages by ore type

² excluding historical tailings

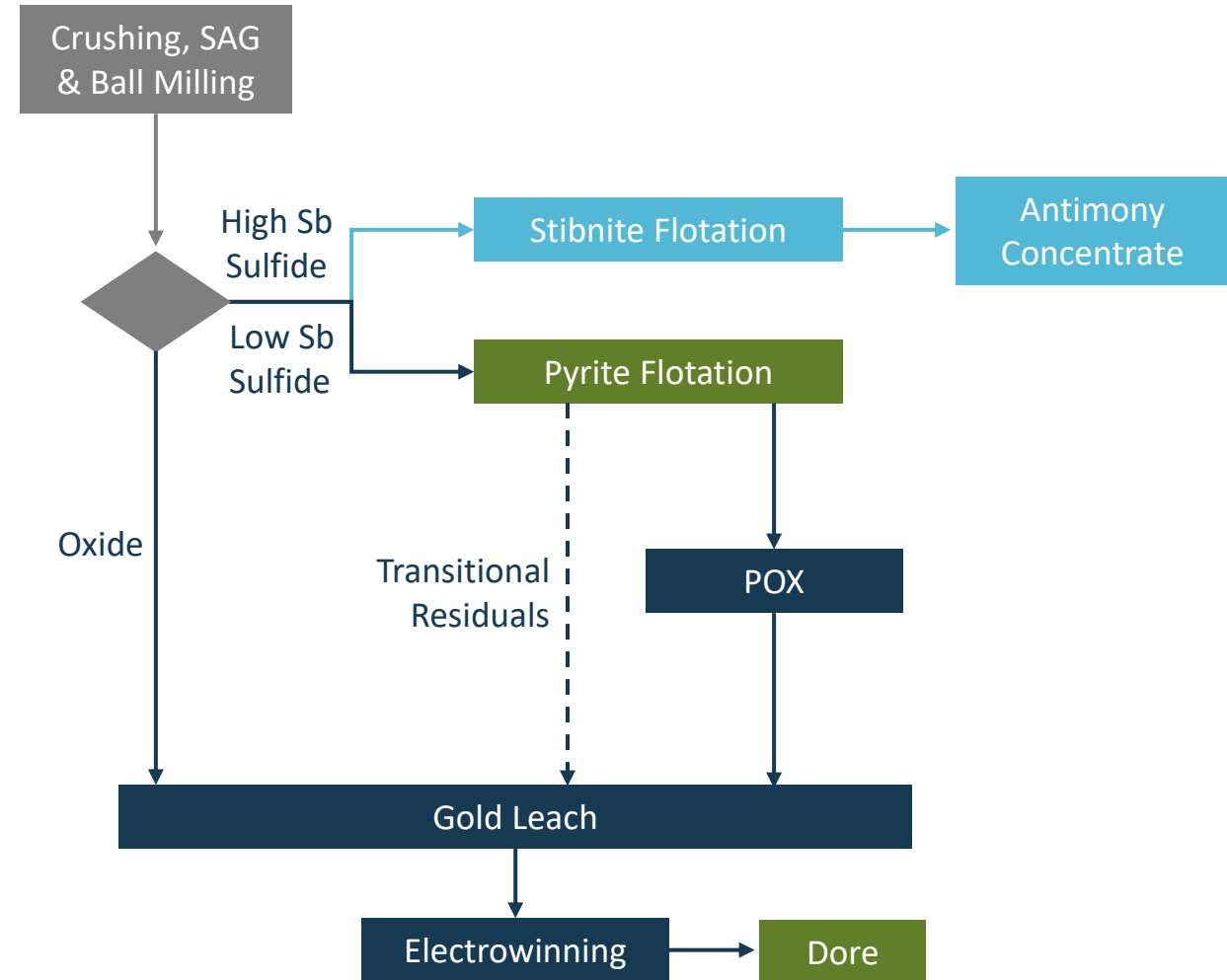

Based on the 2020 Feasibility Study (FS) which is intended to be read as a whole and sections should not be read or relied upon out of context. The information in this presentation is subject to the assumptions, exclusions and qualifications contained in the FS. See "Regulatory Information" at the end of this presentation. For a summary of differences between the FS and TRS, see "Cautionary Note and Technical Disclosure" at the beginning of this presentation



FEASIBILITY STUDY – HIGHLIGHTS¹

Component	Early Production Years 1-4	Life-of-Mine Years 1-15
Total Recovered Gold	1,853 koz	4,238 koz
Total Recovered Antimony	74 Mlbs	115 Mlbs
Average Annual Recovered Gold	463 koz/yr	297 koz/yr
Cash Costs Net of By-Product Credits ²	\$328/koz	\$538/koz
All-in Sustaining Costs Net of By-Product Credits ²	\$438/koz	\$636/koz
Initial Capital including Contingency	\$1,263 million	
\$1,600/oz gold - \$20/oz silver - \$3.50/lb antimony		
After-Tax Net Present Value at 5% Discount Rate	\$1,320 million	
Annual Average EBITDA ²	\$566 million	\$292 million
Annual Average After Tax Free Cash Flow ²	\$500 million	\$242 million
After Tax Internal Rate of Return	22.3%	
After Tax Payback Period	2.9 years	
\$1,850/oz gold - \$24/oz silver - \$3.50/lb antimony		
After-Tax Net Present Value at 5% Discount Rate	\$1,864 million	
Annual Average EBITDA ²	\$678 million	\$360 million
Annual Average After Tax Free Cash Flow ²	\$584 million	\$295 million
After Tax Internal Rate of Return	27.7%	
After Tax Payback Period	2.5 years	

Notes:

1. In this presentation, "M" = million, "k" = thousand, all amounts in US\$, gold and silver reported in troy ounces ("oz")
2. Cash costs, All-in Sustaining Costs, EBITDA and After Tax Free Cash Flow are non-GAAP measures. See "Non-GAAP measures" at the end of this presentation.
3. The FS assumes 100% equity financing of the Project.

Based on the 2020 Feasibility Study (FS) which is intended to be read as a whole and sections should not be read or relied upon out of context. The information in this presentation is subject to the assumptions, exclusions and qualifications contained in the FS. See "Regulatory Information" at the end of this presentation. For a summary of differences between the FS and TRS, see "Cautionary Note and Technical Disclosure" at the beginning of this presentation.



FEASIBILITY STUDY - CAPITAL COST SUMMARY

Area	Detail	Initial CAPEX (M \$)	Sustaining CAPEX (M \$)	Closure CAPEX (M \$) ⁽²⁾	Total CAPEX (M \$)
Direct Costs	Mine Costs ⁽¹⁾	84	119	-	203
	Processing Plant	433	49	-	483
	On-Site Infrastructure	191	84	-	275
	Off-Site Infrastructure	116	-	-	116
Indirect Costs		233	-	-	233
Owner's Costs		38	-	-	38
Offsite Environmental Mitigation Costs		14	-	-	14
Onsite Mitigation, Monitoring and Closure Costs ⁽²⁾		3	23	98	125
Total CAPEX without Contingency⁽³⁾		1,113	275	98	1,487
Contingency		150	20	1	171
Total CAPEX with Contingency⁽³⁾		1,263	296	99	1,658

Notes:

1. Initial mining CAPEX includes environmental remediation costs.
2. Closure and mitigation assume self-performed costs, which will differ for those assumed for financial assurance calculations required by regulators. Costs include stream and wetland restoration and reclamation costs.
3. Numbers have been rounded and may not sum correctly.

Based on the 2020 Feasibility Study (FS) which is intended to be read as a whole and sections should not be read or relied upon out of context. The information in this presentation is subject to the assumptions, exclusions and qualifications contained in the FS. See "Regulatory Information" at the end of this presentation. For a summary of differences between the FS and TRS, see "Cautionary Note and Technical Disclosure" at the beginning of this presentation.



FEASIBILITY STUDY - OPERATING COST SUMMARY

Total Production Cost Item	Years 1-4		Life of Mine	
	(\$/t milled)	(\$/oz Au)	(\$/t milled)	(\$/oz Au)
Mining	9.71	156	8.22	205
Processing	13.13	211	12.76	318
G&A (including Water Treatment)	3.54	57	3.43	85
Cash Costs Before By-Product Credits	26.38	424	24.41	608
By-Product Credits	(5.99)	(96)	(2.81)	(70)
Cash Costs After of By-Product Credits	20.40	328	21.60	538
Royalties	1.69	27	1.09	27
Refining and Transportation	0.46	7	0.24	6
Total Cash Costs¹	22.54	362	22.94	571
Sustaining CAPEX	4.64	75	2.83	70
All-In Sustaining Costs¹	27.23	438	25.54	636
Reclamation and Closure ²	-	-	0.95	24
Initial (non-sustaining) CAPEX ³	-	-	11.65	290
All-In Costs	-	-	38.14	950

Notes:

1. Cash costs and All-in Sustaining Costs are non-GAAP measures. See "Non-GAAP measures" at the end of this presentation.
2. Defined as non-sustaining reclamation and closure costs in the post-operations period.
3. Initial Capital includes capitalized preproduction.

Based on the 2020 Feasibility Study (FS) which is intended to be read as a whole and sections should not be read or relied upon out of context. The information in this presentation is subject to the assumptions, exclusions and qualifications contained in the FS. See "Regulatory Information" at the end of this presentation. For a summary of differences between the FS and TRS, see "Cautionary Note and Technical Disclosure" at the beginning of this presentation.



ANNUAL AFTER-TAX CASH FLOW (@ \$1,850 GOLD PRICE)¹

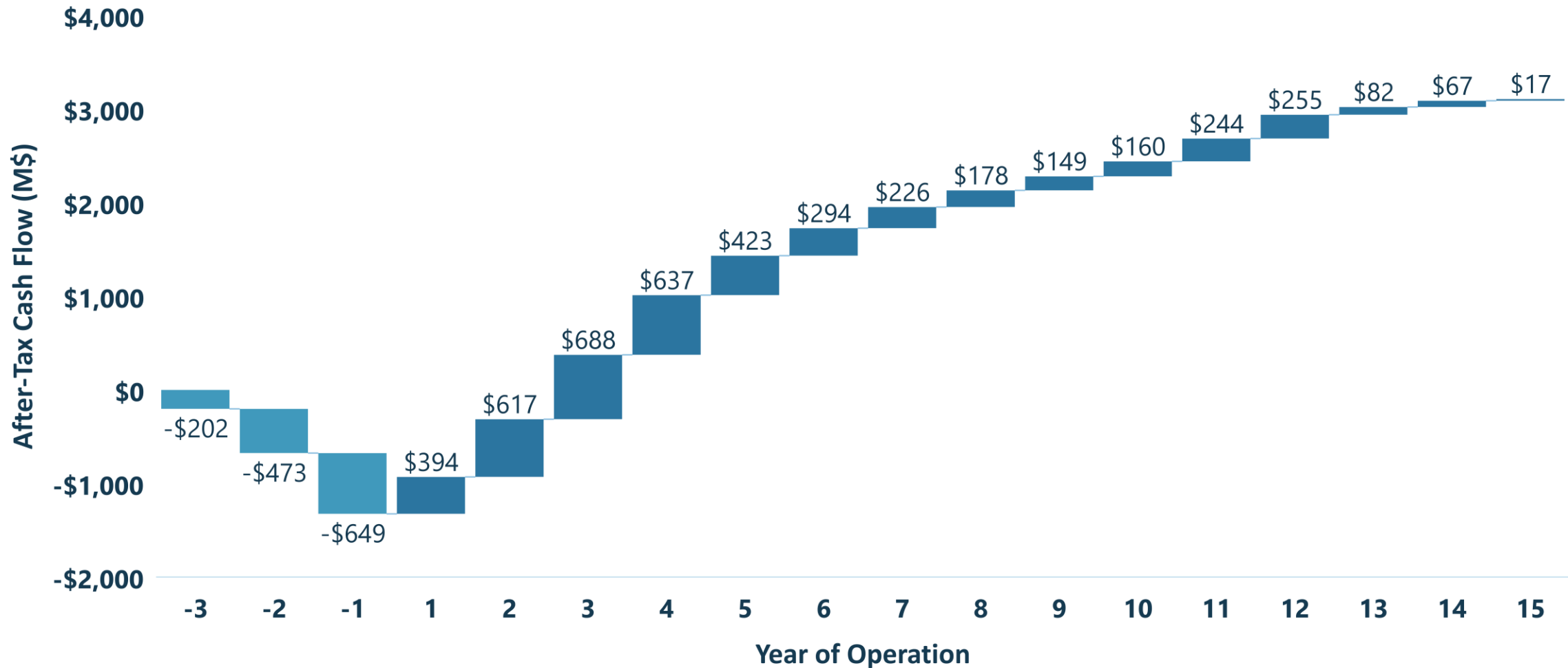

1. Based on the 2020 Feasibility Study (FS) which is intended to be read as a whole and sections should not be read or relied upon out of context. The information in this presentation is subject to the assumptions, exclusions and qualifications contained in the FS. See "Regulatory Information" at the end of this presentation. For a summary of differences between the FS and TRS, see "Cautionary Note and Technical Disclosure" at the beginning of this presentation.



SUPPORTIVE SHAREHOLDER BASE

CAPITAL STRUCTURE*

- ❖ Issued & Outstanding 63.17 Million
- ❖ Options 1.78 Million
- ❖ Share Units 1.36 Million
- ❖ Fully Diluted 66.30 Million
- ❖ Estimated Cash Balance*** ~\$19 Million

SHAREHOLDERS**

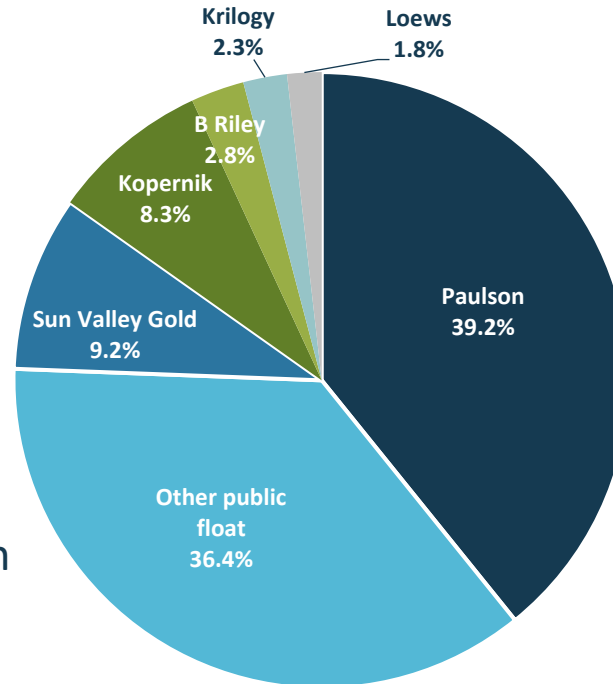

RESEARCH COVERAGE

- ❖ B. Riley Financial – Lucas Pipes
- ❖ H.C. Wainwright – Heiko Ihle
- ❖ Cantor Fitzgerald – Mike Kozak
- ❖ Roth Capital – Mike Niehuser



Perpetua Resources

*Capital structure estimate as of May 12, 2023

**Based on most recent shareholder filings

***Cash balance as of March 31, 2023



REGULATORY INFORMATION

The FS was compiled by M3 Engineering & Technology Corporation (“M3”) in accordance with NI 43-101 under the direction of independent qualified persons (as defined in NI 43-101) (“Independent QPs”). Independent QPs for the FS include: Richard Zimmerman, SME-RM (onsite and offsite infrastructure, cost estimating and financial modeling) and Art Ibrado, P.E. (mineral processing) with M3; Garth Kirkham, P.Geo. (mineral resources) with Kirkham Geosystems Ltd.; Christopher Martin, C.Eng. (metallurgy) with Blue Coast Metallurgy Ltd.; Grenvil Dunn, C.Eng. (hydrometallurgy) with Hydromet WA (Pty) Ltd.; Chris Roos, P.E. (mineral reserves) and Scott Rosenthal P.E. (mine planning) with Value Consulting, Inc.; and Peter Kowalewski, P.E. (tailings storage facility and closure) with Tierra Group International, Ltd.

The TRS was compiled by M3 in compliance with Subpart 1300 promulgated by the SEC under the direction of Independent Qualified Persons (as defined in Subpart 1300) (“QPs”). QPs for the TRS include: Richard Zimmerman, SME-RM (onsite and offsite infrastructure, cost estimating, mineral processing, financial modeling) with M3; Garth Kirkham, P.Geo. (mineral resources) with Kirkham Geosystems Ltd.; Christopher Martin, C.Eng. (metallurgy) with Blue Coast Metallurgy Ltd.; Grenvil Dunn, C.Eng. (hydrometallurgy) with Hydromet WA (Pty) Ltd.; Scott Rosenthal P.E. (mine planning and mineral reserves) with Value Consulting, Inc.; and Peter Kowalewski, P.E. (tailings storage facility and closure) with Tierra Group International, Ltd.

The material scientific and technical information in respect of the Project in this presentation, unless otherwise indicated, is based upon information contained in the FS, with notable differences between the FS and the TRS identified. Readers are encouraged to read the TRS and the Company’s Current Report on Form 8-K filed with the SEC on January 3, 2021, as amended by the Company’s Current Report on Form 8-K/A filed with the SEC on June 8, 2022, which are available under the Company’s profile on EDGAR. Readers also are encouraged to read the FS, which is available under the Company’s profile on SEDAR and on the Company’s website, for detailed information concerning the Project. All disclosure contained in this presentation regarding the mineral reserves and mineral resource estimates and economic analysis on the property is fully qualified by the full disclosure contained in the FS and the TRS.

Information of a scientific or technical nature in this presentation has been approved by Christopher Dail, AIPG CPG #10596, Exploration Manager for Perpetua Resources Idaho, Inc. and a qualified person (as defined in NI 43-101 and as defined in Subpart 1300).

All mineral resources have been estimated in accordance with CIM definitions, with notable differences to Subpart 1300 identified. Mineral resources are reported in relation to a conceptual pit shell to demonstrate potential for economic viability, as required under NI 43-101; mineralization lying outside of these pit shells is not reported as a mineral resource. Mineral resources are not mineral reserves and do not have demonstrated economic viability. Mineral resource estimates include inferred mineral resources that are considered too speculative geologically to have economic considerations applied to them that would enable them to be categorized as mineral reserves. It is reasonably expected that the majority of inferred mineral resources could be upgraded to indicated mineral resources.

The mineral resources and mineral reserves at the Stibnite Gold Project are contained within areas that have seen historic disturbance resulting from prior mining activities. In order for the Company to advance its interests at the Stibnite Gold Project, the Project will be subject to a number of federal, state and local laws and regulations and will require permits to conduct its activities.

See also “Cautionary Note” at the beginning of this presentation.

OTHER

Certain monetary amounts, percentages and other figures included in this presentation have been subject to rounding adjustments. Certain other amounts that appear in this presentation may not sum due to rounding.



NON-GAAP MEASURES

NON-GAAP MEASURES

To provide investors with additional information in connection with our results as determined in accordance with generally accepted accounting principles in the United States (“GAAP”), we disclose certain projected non-GAAP financial measures. The projected non-GAAP financial measures include Cash Costs, EBITDA, All-in Sustaining Costs and After-Tax Free Cash Flow estimates and related calculations as published in the Company’s 2020 Feasibility Study.

1. Cash Costs and All-in Sustaining Costs (AISC)

Cash Costs is a non-GAAP metric defined as the sum of cash operating costs (mining, processing, G&A), by-product credits, refining and transportation costs and royalties and is used to evaluate the Company’s future operating performance and provide visibility into the economics of our future mining operations.

All-in Sustaining Costs (AISC) is a non-GAAP metric defined as the sum of cash costs (from above), sustaining capital costs and non-revenue-based taxes (i.e. property tax) and is used to evaluate the Company’s future operating performance and the ability to generate cash flow from operations.

2. EBITDA

Earnings before interest, taxes and depreciation and amortization (EBITDA) is a non-GAAP metric is generated from adding back taxes, interest, depreciation to net income and is used to evaluate the Company’s future operating performance.

3. After-Tax Free Cash Flow (FCF)

After-Tax Free Cash Flow (FCF) is a non-GAAP metric and is defined as net cash provided from operating activities less capital expenditures and less taxes and is used to evaluate the Company’s future operating performance and ability to generate excess cash flow but it does not entirely represent cash available for discretionary expenditures due to the fact that the measure does not deduct the payments required for debt service and other items.

We believe the projected non-GAAP financial measures included in this presentation provide readers with additional meaningful comparisons between the Company’s 2020 Feasibility Study and its peer companies. These projected non-GAAP financial measures are not historical measures of financial performance and are not presented in accordance with GAAP. They may exclude items that will be significant in understanding and assessing our financial results. Therefore, these measures should not be considered in isolation or as an alternative or superior to GAAP measures. You should be aware that our presentation of these measures may not be comparable to similarly-titled measures used by other companies. The projected non-GAAP measures included in this presentation cannot be reconciled to comparable GAAP measures without unreasonable effort.

The non-GAAP financial measures included in this presentation are projections based on the 2020 Feasibility Study. They are forward-looking statements and remain subject to the risks and uncertainties set forth in the section titled “Forward-Looking Statements” at the beginning of this presentation.

See the 2020 Feasibility Study for additional information regarding the non-GAAP financial measures included in this presentation. The economic model described in the 2020 Feasibility Study is not a true cash flow model as defined by financial accounting standards but rather a representation of Project economics at a level of detail appropriate for a feasibility study level of engineering and design.